

PER:
FOR:

ABUS (D)

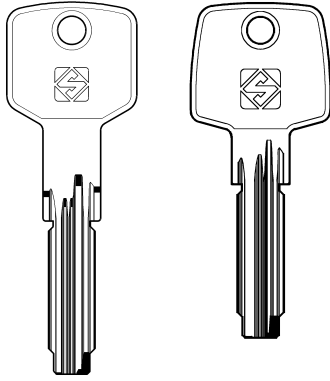

AB48

AB84

AB74

ASTRAL system:

Codes tables protected by a password issued by Silca on receipt of the manufacturer's authorization.

Tabella codici protetta da password rilasciata da Silca a fronte di autorizzazione del costruttore.

Code-Tabellen geschützt durch von Silca geliefertes Passwort auf Herstellersgenehmigung.

Tables de codes protégées par un password qui est émis par Silca sur autorisation du Constructeur.

Tablas codigos protegidos con contraseña que manda Silca previa autorización.

Tabelas de códigos protegidas por uma password emitida por Silca contra autorização do fabricante.

OPTIONAL



D743261ZB

05J Jaw
Ganascia 05J
05J Backe
Mâchoire 05J
Quijada 05J
Garra 05J



OPTIONAL



D743262ZB

06J Jaw
Ganascia 06J
06J Backe
Mâchoire 06J
Quijada 06J
Garra 06J

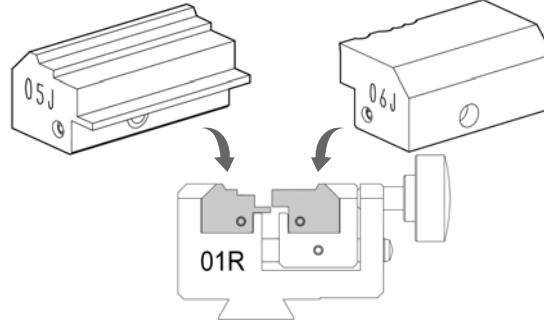

STANDARD



D742867ZB

Cutter 01D
Fresa 01D
Fräser 01D
Fraise 01D
Fresa 01D
Fresa 01D

PER:
FOR:

ABUS (D)

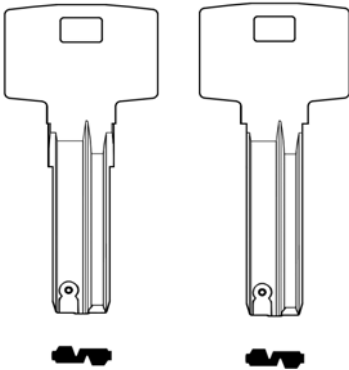

Bravus

(1000 - 2000 - 3000 - 4000)

System protected by a password issued by Silca on receipt of authorization.

Sistema protetto da password rilasciata da Silca a fronte di autorizzazione.

System geschützt durch von Silca geliefertes Passwort auf Genehmigung.

Système protégé par un password qui est émis par Silca sur autorisation.

Sistema protegido con contraseña que manda Silca previa autorización.

Sistema protegido por uma password emitida por Silca contra a autorização.

OPTIONAL



D744315ZB

29J Jaw
Ganascia 29J
29J Backe
Mâchoire 29J
Quijada 29J
Garra 29J



OPTIONAL



D744317ZB

30J Jaw
Ganascia 30J
30J Backe
Mâchoire 30J
Quijada 30J
Garra 30J

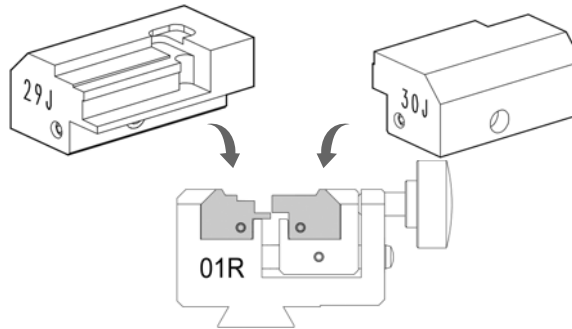

1000 - 2000 - 3000 systems

OPTIONAL



D744355ZB

Cutter 07D
Fresa 07D
Fräser 07D
Fraise 07D
Fresa 07D
Fresa 07D

4000 system

OPTIONAL



D744355ZB

Cutter 07D
Fresa 07D
Fräser 07D
Fraise 07D
Fresa 07D
Fresa 07D

OPTIONAL



D743672ZB

Cutter 03L
Fresa 03L
Fräser 03L
Fraise 03L
Fresa 03L
Fresa 03L

FOR:
PER:

ABUS (D)

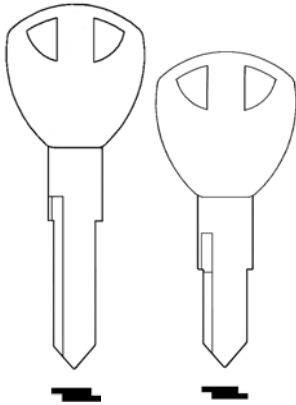

Abus Bike
(8N - 6N)

OPTIONAL D751310ZB



92J Jaw
Ganascia 92J
92J Backe
Mâchoire 92J
Quijada 92J
Garra 92J

OPTIONAL D751330ZB



93J Jaw
Ganascia 93J
93J Backe
Mâchoire 93J
Quijada 93J
Garra 93J

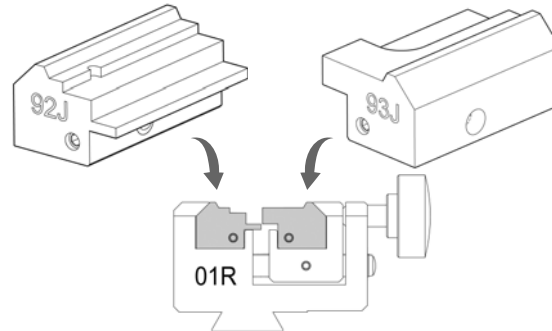

OPTIONAL



D751336ZB

Cutter 09L
Fresa 09L
Fräser 09L
Fraise 09L
Fresa 09L
Fresa 09L

PER:
FOR:

ASSA (SE)

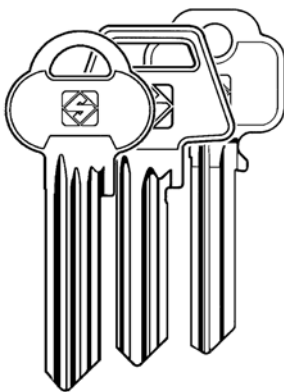

6-7 PIN KEYS

(DP, CLIQ)
(D-12)

OPTIONAL

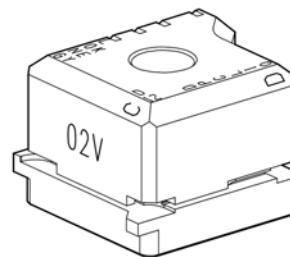

D743271ZB

02V clamp for ASSA type keys (long keys, D-12*, DP, CLIQ)
Morsetto 02V per chiavi tipo ASSA (chiavi lunghe, D-12*, DP, CLIQ)
Spannbacke 02V für ASSA Schlüsseltyp (lange Schlüssel, D-12*, DP, CLIQ)
Étau 02V pour clés type ASSA (clés longues, D-12*, DP, CLIQ)
Mordaza 02V para llaves de tipo ASSA (llaves largas, D-12*, DP, CLIQ)
Mordente 02V para chaves do tipo ASSA (chaves longas, D-12*, DP, CLIQ)

*D-12: Key duplicable by code only
*D-12: Chiave duplicabile solo a codice
*D-12: Kopierenschlüssel nur zur Code
*D-12: Clé à copier uniquement par code
*D-12: Llave duplicable sólo a código
*D-12: Chave duplicable somente por código

PER:
FOR:

ASSA (SE)

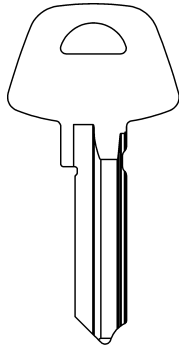

(D-12)

System protected by a password issued by Silca on receipt of authorization.

Sistema protetto da password rilasciata da Silca a fronte di autorizzazione.

System geschützt durch von Silca geliefertes Password auf Genehmigung.

Système protégé par un password qui est émis par Silca sur autorisation.

Sistema protegido con contraseña que manda Silca previa autorización.

Sistema protegido por uma password emitida por Silca contra a autorização.

OPTIONAL D744283ZB

- CODE 20J Jaw
- CODE Ganascia 20J
- ◊ COPY 20J Backe
- ◊ COPY Mâchoire 20J
- ◊ COPY Quijada 20J
- ◊ COPY Garra 20J

OPTIONAL D744284ZB

- CODE 21J Jaw
- CODE Ganascia 21J
- ◊ COPY 21J Backe
- ◊ COPY Mâchoire 21J
- ◊ COPY Quijada 21J
- ◊ COPY Garra 21J

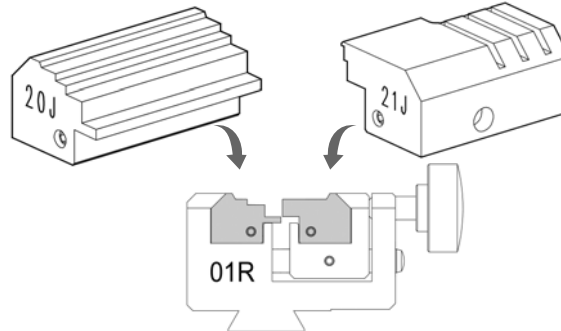

OPTIONAL



D743745ZB

- Cutter 04L
- Fresa 04L
- Fräser 04L
- Fraise 04L
- Fresa 04L
- Fresa 04L

PER:
FOR:

ASSA (SE)

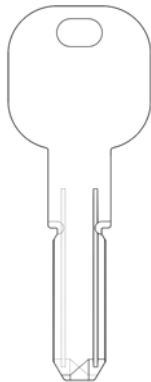

SYSTEM	CARD	SN
ASSA ABLOY K100	4239	1870
IKON RW6	4239	1871
Union keyPRIME™	4239	1873
Vachette Vercy	4239	1877
ASSA ABLOY CY110	4239	1874
IKONRW6 (Main+Side Row)	4241	1875

System protected by a password issued by Silca on receipt of authorization.

Sistema protetto da password rilasciata da Silca a fronte di autorizzazione.

System geschützt durch von Silca geliefertes Password auf Genehmigung.

Système protégé par un password qui est émis par Silca sur autorisation.

Sistema protegido con contraseña que manda Silca previa autorización.

Sistema protegido por uma password emitida por Silca contra a autorização.

OPTIONAL D749002ZB

- CODE 86J Jaw
- CODE Ganascia 86J
- ◊ COPY 86J Backe
- ◊ COPY Mâchoire 86J
- ◊ COPY Quijada 86J
- ◊ COPY Garra 86J

OPTIONAL D749004ZB

- CODE 87J Jaw
- CODE Ganascia 87J
- ◊ COPY 87J Backe
- ◊ COPY Mâchoire 87J
- ◊ COPY Quijada 87J
- ◊ COPY Garra 87J

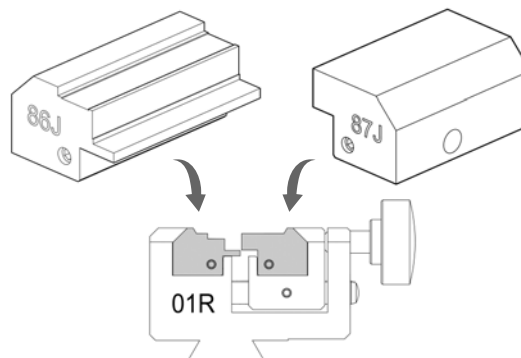

STANDARD



D742867ZB

- Cutter 01D
- Fresa 01D
- Fräser 01D
- Fraise 01D
- Fresa 01D
- Fresa 01D

PER:
FOR:

BKS (D)

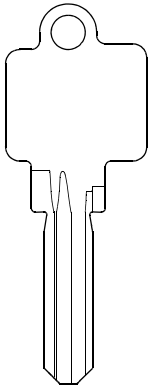



(WS42)

OPTIONAL

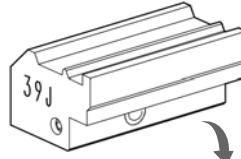

D744485ZB

39J Jaw
Ganascia 39J
39J Backe
Mâchoire 39J
Quijada 39J
Garra 39J



OPTIONAL



D744482ZB

38J Jaw
Ganascia 38J
38J Backe
Mâchoire 38J
Quijada 38J
Garra 38J

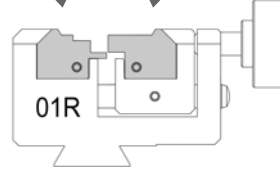
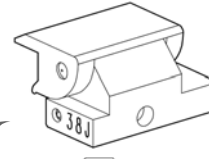

OPTIONAL





D744514ZB

Cutter 08L
Fresa 08L
Fräser 08L
Fraise 08L
Fresa 08L
Fresa 08L

PER:
FOR:

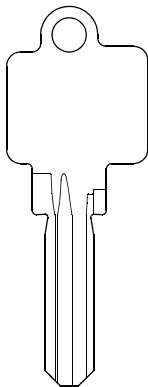
BKS (D)





WS50 MK
(Profiles RA-RK-RZ)

OPTIONAL

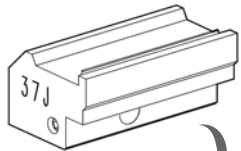

D744480ZB

37J Jaw
Ganascia 37J
37J Backe
Mâchoire 37J
Quijada 37J
Garra 37J



OPTIONAL



D744482ZB

38J Jaw
Ganascia 38J
38J Backe
Mâchoire 38J
Quijada 38J
Garra 38J

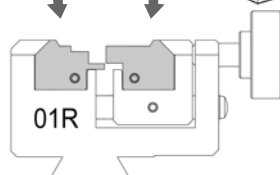
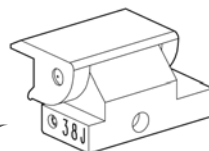

OPTIONAL



D744514ZB

Cutter 08L
Fresa 08L
Fräser 08L
Fraise 08L
Fresa 08L
Fresa 08L

PER:
FOR:

CES (D)

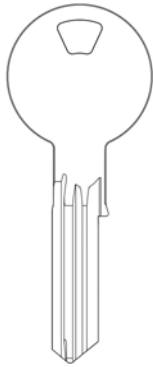

(UDM)

System protected by a password issued by Silca on receipt of authorization.

Sistema protetto da password rilasciata da Silca a fronte di autorizzazione.

Sysyem geschützt durch von Silca geliefertes Password auf Genehmigung.

Système protégé par un password qui est émis par Silca sur autorisation.

Sistema protegido con contraseña que manda Silca previa autorización.

Sistema protegido por uma password emitida por Silca contra a autorização.

OPTIONAL



D744505ZB

49J Jaw
Ganascia 49J
49J Backe
Mâchoire 49J
Quijada 49J
Garra 49J



OPTIONAL



D744311ZB

25J Jaw
Ganascia 25J
25J Backe
Mâchoire 25J
Quijada 25J
Garra 25J

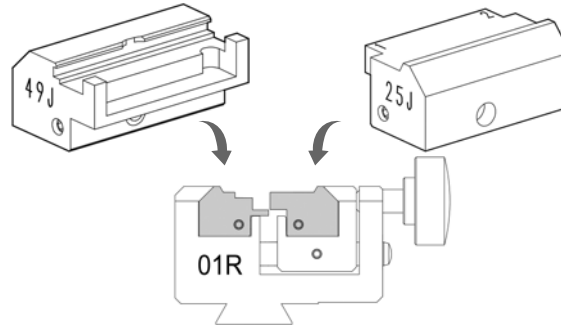

OPTIONAL



D744513ZB

Cutter 12D
Fresa 12D
Fräser 12D
Fraise 12D
Fresa 12D
Fresa 12D

PER:
FOR:

CES (D)

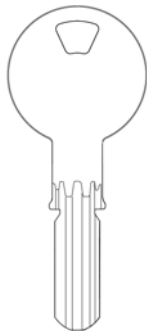

(WSM NEW)

System protected by a password issued by Silca on receipt of authorization.

Sistema protetto da password rilasciata da Silca a fronte di autorizzazione.

Sysyem geschützt durch von Silca geliefertes Password auf Genehmigung.

Système protégé par un password qui est émis par Silca sur autorisation.

Sistema protegido con contraseña que manda Silca previa autorización.

Sistema protegido por uma password emitida por Silca contra a autorização.

STANDARD



D943253ZR

01J Jaw
Ganascia 01J
01J Backe
Mâchoire 01J
Quijada 01J
Garra 01J



STANDARD



D943254ZR

02J Jaw
Ganascia 02J
02J Backe
Mâchoire 02J
Quijada 02J
Garra 02J

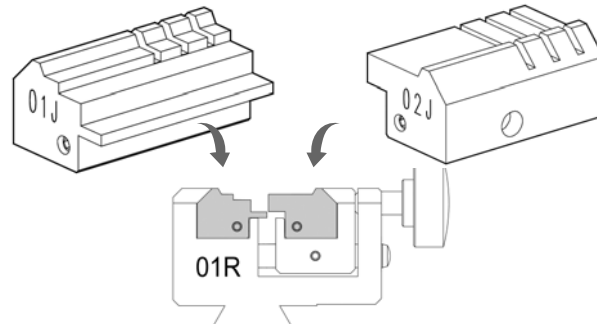

OPTIONAL



D744510ZB

Cutter 11D
Fresa 11D
Fräser 11D
Fraise 11D
Fresa 11D
Fresa 11D

PER:
FOR:

CISA (I)



 CS70P

 CS70

 CS62

ASTRAL
system 357

 AB48
ABUS

OPTIONAL

D743261ZB



05J Jaw
Ganascia 05J
05J Backe
Mâchoire 05J
Quijada 05J
Garra 05J



OPTIONAL

D743262ZB



06J Jaw
Ganascia 06J
06J Backe
Mâchoire 06J
Quijada 06J
Garra 06J

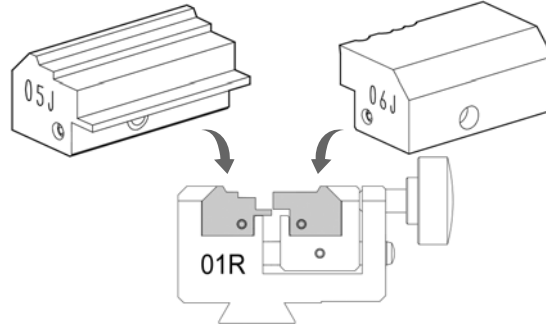

STANDARD

D742867ZB



Cutter 01D
Fresa 01D
Fräser 01D
Fraise 01D
Fresa 01D
Fresa 01D

ASTRAL system:

Codes tables protected by a password issued by Silca on receipt of the manufacturer's authorization.

Tabelle codici protette da password rilasciata da Silca a fronte di autorizzazione del costruttore.

Code-Tabellen geschützt durch von Silca geliefertes Password auf Herstellersgenehmigung.

Tables de codes protégées par un password qui est émis par Silca sur autorisation du Constructeur.

Tablas codigos protegidos con contraseña que manda Silca previa autorización.

Tabelas de códigos protegidas por uma password emitida por Silca contra autorização do fabricante.

PER:
FOR:

DOM (D)

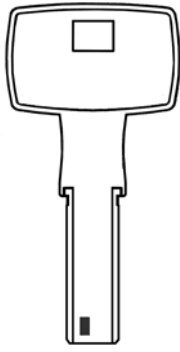

(IX-SATS)

SYSTEM	CARD	SN
Dom IX SATS (Pr. 169)	3789	1507
Dom IX SATS (Pr. 170)	3790	1508
Dom IX SATS (Pr. 171)	3791	1509
Dom IX SATS (Pr. 172)	3792	1510
Dom IX SATS (Pr. 167)	3929	1644
Dom IX SATS (Pr.169-170-171-172) (Precoded)	3788	1506

System protected by a password issued by Silca on receipt of authorization.

Sistema protetto da password rilasciata da Silca a fronte di autorizzazione.

System geschützt durch von Silca geliefertes Password auf Genehmigung.

Système protégé par un password qui est émis par Silca sur autorisation.

Sistema protegido con contraseña que manda Silca previa autorización.

Sistema protegido por uma password emitida por Silca contra a autorização.

OPTIONAL D751041ZB



91J Jaw
Ganascia 91J
91J Backe
Mâchoire 91J
Quijada 91J
Garra 91J



STANDARD D943254ZR



02J Jaw
Ganascia 02J
02J Backe
Mâchoire 02J
Quijada 02J
Garra 02J

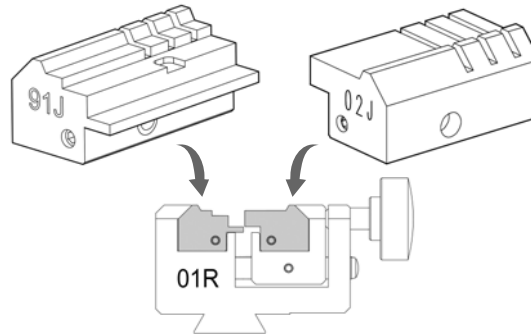

OPTIONAL



D744508ZB

Cutter 09D
Fresa 09D
Fräser 09D
Fraise 09D
Fresa 09D
Fresa 09D

PER:
FOR:

DOM (D)

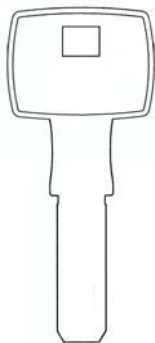

IX6SR E

(prof. 129, 130, 241)

(prof. 131, 132, 233)

(prof. 230, 232 AT, 234 AT, 235)

System protected by a password issued by Silca on receipt of authorization.

Sistema protetto da password rilasciata da Silca a fronte di autorizzazione.

System geschützt durch von Silca geliefertes Password auf Genehmigung.

Système protégé par un password qui est émis par Silca sur autorisation.

Sistema protegido con contraseña que manda Silca previa autorización.

Sistema protegido por uma password emitida por Silca contra a autorização.

OPTIONAL



D744495ZB

44J Jaw
Ganascia 44J
44J Backe
Mâchoire 44J
Quijada 44J
Garra 44J



STANDARD

D943254ZR

02J Jaw
Ganascia 02J
02J Backe
Mâchoire 02J
Quijada 02J
Garra 02J

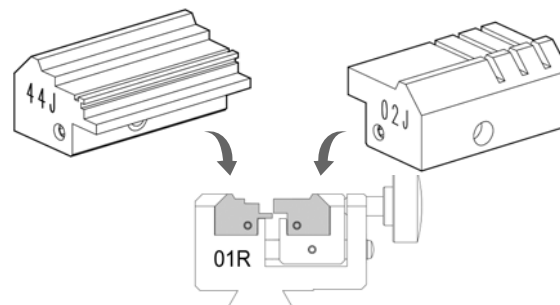

OPTIONAL



D744508ZB

Cutter 09D
Fresa 09D
Fräser 09D
Fraise 09D
Fresa 09D
Fresa 09D

PER:
FOR:

DOM (D)

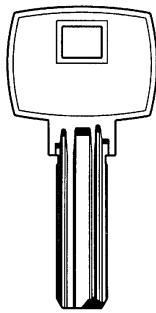

IXGAMMA
(prof. 154)

System protected by a password issued by Silca on receipt of authorization.

Sistema protetto da password rilasciata da Silca a fronte di autorizzazione.

System geschützt durch von Silca geliefertes Password auf Genehmigung.

Système protégé par un password qui est émis par Silca sur autorisation.

Sistema protegido con contraseña que manda Silca previa autorización.

Sistema protegido por uma password emitida por Silca contra a autorização.

OPTIONAL



D744499ZB

46J Jaw
Ganascia 46J
46J Backe
Mâchoire 46J
Quijada 46J
Garra 46J

OPTIONAL



D744497ZB

45J Jaw
Ganascia 45J
45J Backe
Mâchoire 45J
Quijada 45J
Garra 45J

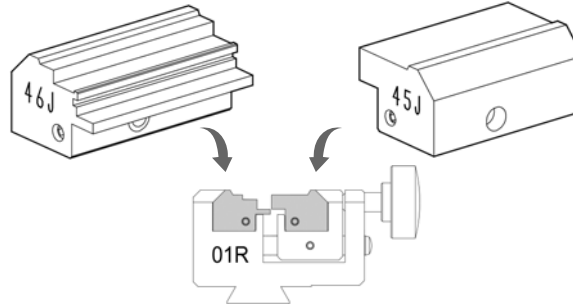

OPTIONAL



D744508ZB

Cutter 09D
Fresa 09D
Fräser 09D
Fraise 09D
Fresa 09D
Fresa 09D

PER:
FOR:

DOM (D)

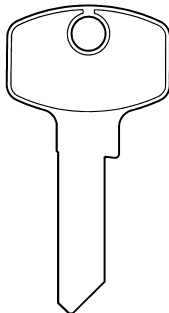

(Prof.145)

SIGMA

System protected by a password issued by Silca on receipt of authorization.

Sistema protetto da password rilasciata da Silca a fronte di autorizzazione.

System geschützt durch von Silca geliefertes Password auf Genehmigung.

Système protégé par un password qui est émis par Silca sur autorisation.

Sistema protegido con contraseña que manda Silca previa autorización.

Sistema protegido por uma password emitida por Silca contra a autorização.

OPTIONAL



D744319ZB

31J Jaw
Ganascia 31J
31J Backe
Mâchoire 31J
Quijada 31J
Garra 31J

OPTIONAL



D744321ZB

32J Jaw
Ganascia 32J
32J Backe
Mâchoire 32J
Quijada 32J
Garra 32J

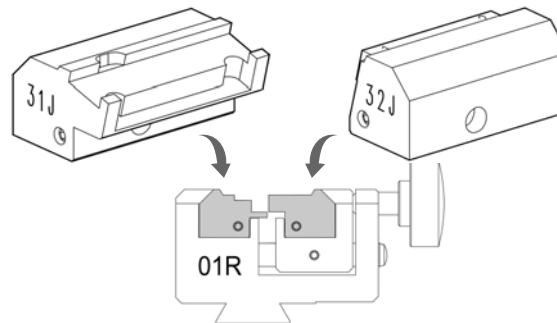

OPTIONAL



D744354ZB

Cutter 05D
Fresa 05D
Fräser 05D
Fraise 05D
Fresa 05D
Fresa 05D

Note: standard cutting is also required.
Nota: è necessaria anche la cifratura standard.
Hinweis: Standard Fräsung ist auch erforderlich.
Remarque: il faut aussi nécessaire le taillage standard.
Nota: también es necesario el corte estándar.
Observação: o corte standard es também necessário

PER:
FOR:

DOM (D) CORBIN (I)

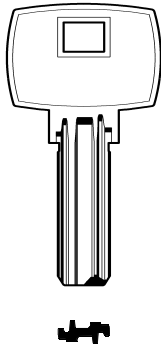

IX5 DAS
(prof. 038/101)

OPTIONAL



D744487ZB

40J Jaw
Ganascia 40J
40J Backe
Mâchoire 40J
Quijada 40J
Garra 40J



OPTIONAL



D744489ZB

41J Jaw
Ganascia 41J
41J Backe
Mâchoire 41J
Quijada 41J
Garra 41J

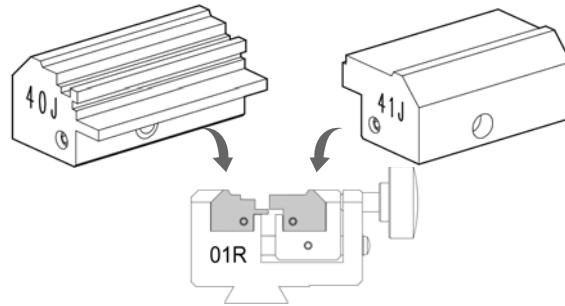

STANDARD



D742867ZB

Cutter 01D
Fresa 01D
Fräser 01D
Fraise 01D
Fresa 01D
Fresa 01D

PER:
FOR:

DOM (D) CORBIN (I)

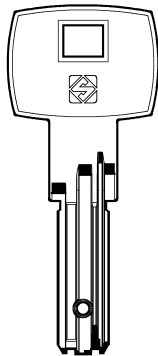

DM144

(IX6 KG Profile 121)

OPTIONAL



D743269ZB

09J Jaw
Ganascia 09J
09J Backe
Mâchoire 09J
Quijada 09J
Garra 09J



OPTIONAL



D743270ZB

10J Jaw
Ganascia 10J
10J Backe
Mâchoire 10J
Quijada 10J
Garra 10J

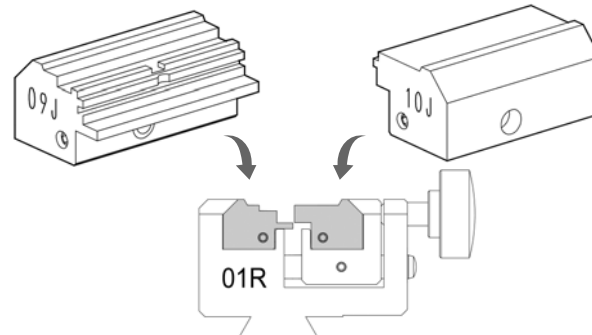

STANDARD



D742867ZB

Cutter 01D
Fresa 01D
Fräser 01D
Fraise 01D
Fresa 01D
Fresa 01D

FOR:
PER:

DOM (D)

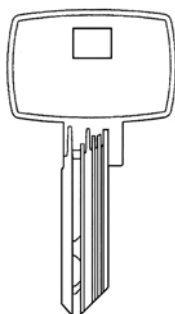

(RS8)

OPTIONAL



D744762ZB

05V clamp for DOM RS8 type keys
Morsetto 05V per chiavi tipo DOM RS8
Spannbacke 05V für DOM RS8 Schlüsseltyp
Etau 05V pour clés type DOM RS8
Mordaza 05V para llaves de tipo DOM RS8
Mordente 05V para chaves do tipo DOM RS8

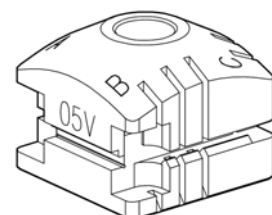

FOR:
PER:

EVVA (AT)

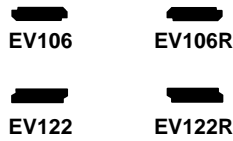
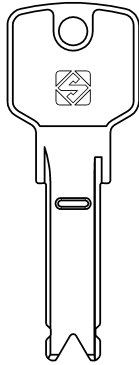

Silca SK3

SIDE



OPTIONAL D743263ZB
 07J Jaw
 Ganascia 07J
 07J Backe
 Mâchoire 07J
 Quijada 07J
 Garra 07J



OPTIONAL D743264ZB
 08J Jaw
 Ganascia 08J
 08J Backe
 Mâchoire 08J
 Quijada 08J
 Garra 08J

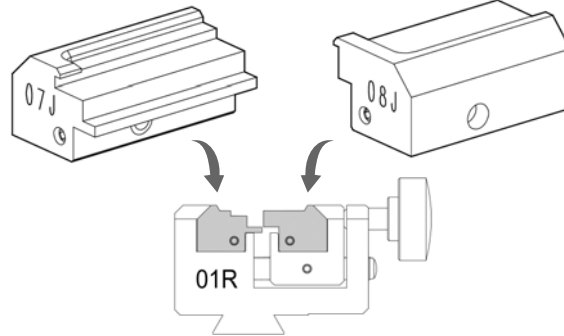

OPTIONAL D745913ZB
 05T Tracer
 Tastatore 05T
 Taster 05T
 Palpeur 05T
 Palpador 05T
 Palpador 05T



OPTIONAL D743745ZB
 04L Cutter
 Fresa 04L
 Fräser 04L
 Fraise 04L
 Fresa 04L
 Fresa 04L



BACK



STANDARD D943253ZR
 01J Jaw
 Ganascia 01J
 01J Backe
 Mâchoire 01J
 Quijada 01J
 Garra 01J



STANDARD D943254ZR
 02J Jaw
 Ganascia 02J
 02J Backe
 Mâchoire 02J
 Quijada 02J
 Garra 02J

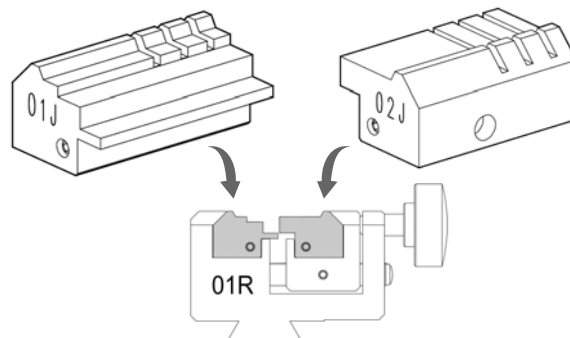

STANDARD D942565ZR
 01T Tracer
 Tastatore 01T
 Taster 01T
 Palpeur 01T
 Palpador 01T
 Palpador 01T



STANDARD D742867ZB
 01D Cutter
 Fresa 01D
 Fräser 01D
 Fraise 01D
 Fresa 01D
 Fresa 01D



PER:
FOR:

HUWIL (D)

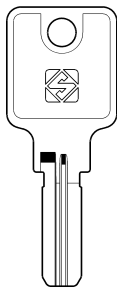

HW15R

OPTIONAL D743362ZB

- ◆ **CODE**
- ◊ **COPY**
- 16J Jaw
- Ganascia 16J
- 16J Backe
- Mâchoire 16J
- Quijada 16J
- Garra 16J

OPTIONAL D743365ZB

- ◆ **CODE**
- ◊ **COPY**
- 17J Jaw
- Ganascia 17J
- 17J Backe
- Mâchoire 17J
- Quijada 17J
- Garra 17J

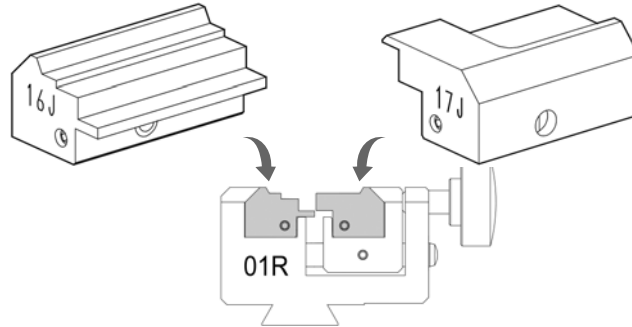

STANDARD D747838ZB



- Cutter 01LW
- Fresa 01LW
- Fräser 01LW
- Fraise 01LW
- Fresa 01LW
- Fresa 01LW

OPTIONAL D742606ZB



- Cutter 01L
- Fresa 01L
- Fräser 01L
- Fraise 01L
- Fresa 01L
- Fresa 01L

PER:
FOR:

ISEO (I)

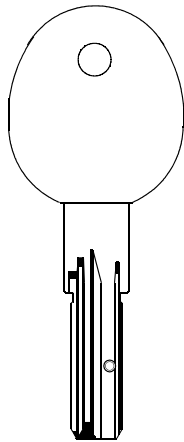

(ISR100 WEB / R100 / R50)

OPTIONAL D743278ZB

- ◆ **CODE**
- ◊ **COPY**
- 11J Jaw
- Ganascia 11J
- 11J Backe
- Mâchoire 11J
- Quijada 11J
- Garra 11J

STANDARD D943254ZR

- ◆ **CODE**
- ◊ **COPY**
- 02J Jaw
- Ganascia 02J
- 02J Backe
- Mâchoire 02J
- Quijada 02J
- Garra 02J

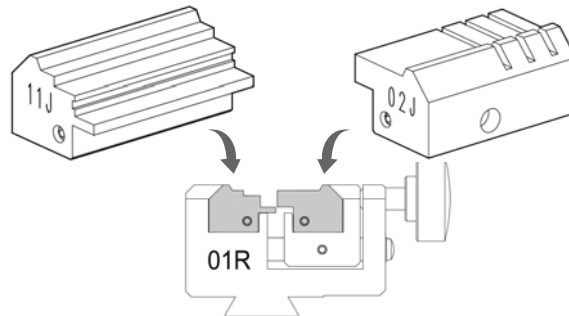

STANDARD D742867ZB



- Cutter 01D
- Fresa 01D
- Fräser 01D
- Fraise 01D
- Fresa 01D
- Fresa 01D

Codes tables protected by a password issued by Silca on receipt of the manufacturer's authorization.

Tabelle codici protette da password rilasciata da Silca a fronte di autorizzazione del costruttore.

Code-Tabellen geschützt durch von Silca geliefertes Passwort auf Herstellergenehmigung.

Tables de codes protégées par un password qui est émis par Silca sur autorisation du Constructeur.

Tablas códigos protegidos con contraseña que manda Silca previa autorización.

Tabelas de códigos protegidas por uma password emitida por Silca contra autorização do fabricante.

PER:
FOR:

KABA (CH)



maTriX
(K59)

OPTIONAL D744295ZB



33J Jaw
Ganascia 33J
33J Backe
Mâchoire 33J
Quijada 33J
Garra 33J



OPTIONAL D744296ZB



34J Jaw
Ganascia 34J
34J Backe
Mâchoire 34J
Quijada 34J
Garra 34J

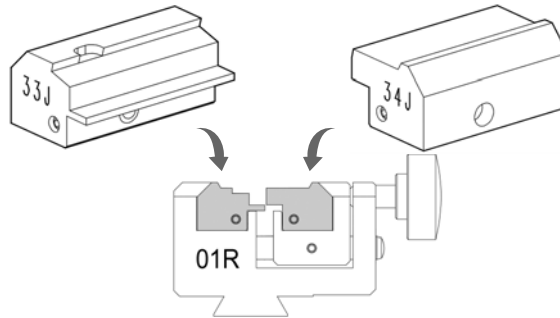

STANDARD



D742867ZB

Cutter 01D
Fresa 01D
Fräser 01D
Fraise 01D
Fresa 01D
Fresa 01D

PER:
FOR:

KABA (CH)

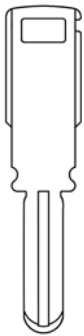

(KABA Exper T)

OPTIONAL



D746713ZB

Clamp 05R
Morsetto 05R
Spannbacke 05R
Etau 05R
Mordaza 05R
Mordente 05R

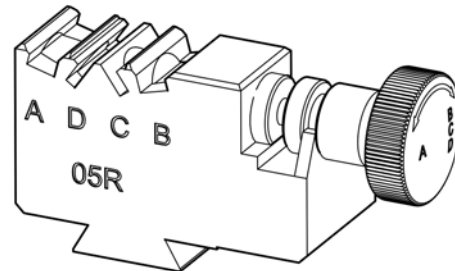

OPTIONAL



D746736ZB

Cutter 10D
Fresa 10D
Fräser 10D
Fraise 10D
Fresa 10D
Fresa 10D

System protected by a password issued by Silca on receipt of authorization.

Sistema protetto da password rilasciata da Silca a fronte di autorizzazione.

Passwort geschütztes System - Freigabe des Herstellers erforderlich.

Système protégé par un password qui est émis par Silca sur autorisation.

Sistema protegido con contraseña que manda Silca previa autorización.

Sistema protegido por uma password emitida por Silca contra a autorização.

PER:
FOR:

KABA (CH)

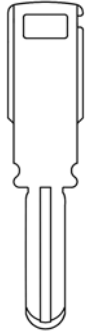

(MaTriX Plus)
(MaTriX Entro)

System protected by a password issued by Silca on receipt of authorization.

Sistema protetto da password rilasciata da Silca a fronte di autorizzazione.

Passwort geschütztes System - Freigabe des Herstellers erforderlich.

Système protégé par un password qui est émis par Silca sur autorisation.

Sistema protegido con contraseña que manda Silca previa autorización.

Sistema protegido por uma password emitida por Silca contra a autorização.

OPTIONAL



D751854ZB

Clamp 06R
Morsetto 06R
Spannbacke 06R
Etau 06R
Mordaza 06R
Mordente 06R

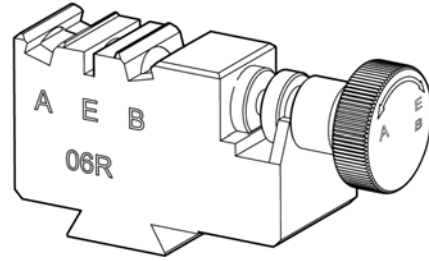

OPTIONAL



D746736ZB

Cutter 10D
Fresa 10D
Fräser 10D
Fraise 10D
Fresa 10D
Fresa 10D

PER:
FOR:

KABA (CH)

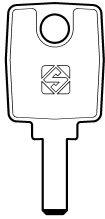

KA8
(KABA-MICRO)

OPTIONAL



D729845ZB

A18 adapter
Adattatore A18
Adapter A18
Adaptateur A18
Adaptador A18
Adaptador A18

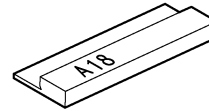

STANDARD



D943253ZR

01J Jaw
Ganascia 01J
01J Backe
Mâchoire 01J
Quijada 01J
Garra 01J

STANDARD



D943254ZR

02J Jaw
Ganascia 02J
02J Backe
Mâchoire 02J
Quijada 02J
Garra 02J

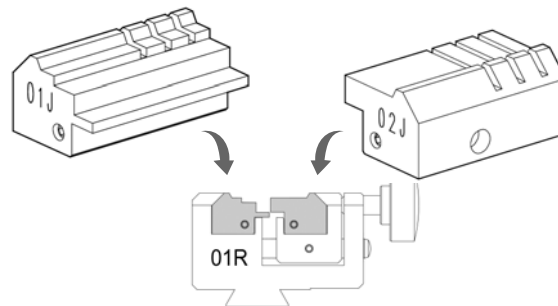

STANDARD



D742867ZB

Cutter 01D
Fresa 01D
Fräser 01D
Fraise 01D
Fresa 01D
Fresa 01D

PER:
FOR:

KABA (CH)



Miwa

OPTIONAL D748720ZB



84J Jaw
Ganascia 84J
84J Backe
Mâchoire 84J
Quijada 84J
Garra 84J

OPTIONAL D748722ZB



85J Jaw
Ganascia 85J
85J Backe
Mâchoire 85J
Quijada 85J
Garra 85J

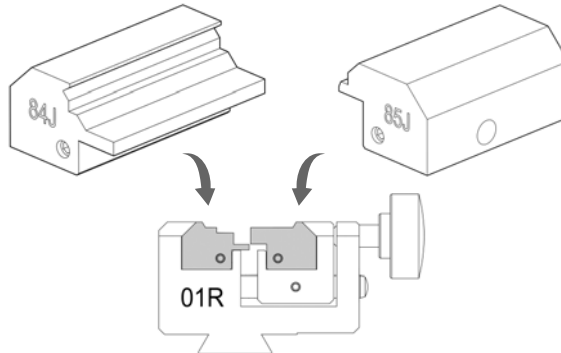

OPTIONAL



D748724ZB

Cutter 17D
Fresa 17D
Fräser 17D
Fraise 17D
Fresa 17D
Fresa 17D

PER:
FOR:

KESO (CH)

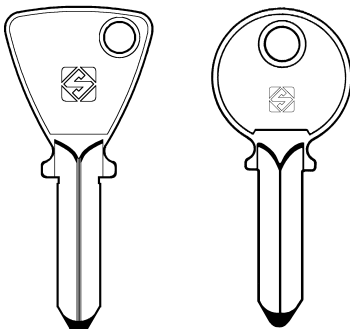

KE1

KE2

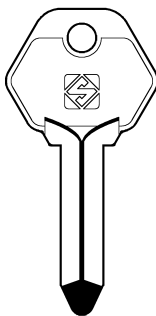

KE4

(1000 System)

OPTIONAL D744291ZB



26J Jaw
Ganascia 26J
26J Backe
Mâchoire 26J
Quijada 26J
Garra 26J

OPTIONAL D744292ZB



27J Jaw
Ganascia 27J
27J Backe
Mâchoire 27J
Quijada 27J
Garra 27J

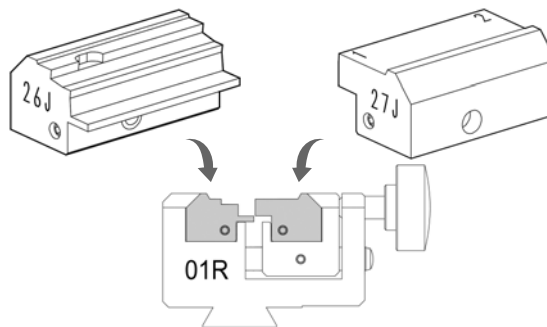

STANDARD



D742867ZB

Cutter 01D
Fresa 01D
Fräser 01D
Fraise 01D
Fresa 01D
Fresa 01D

OPTIONAL



D743674ZB

Cutter 03D
Fresa 03D
Fräser 03D
Fraise 03D
Fresa 03D
Fresa 03D

PER:
FOR:

KYR (I)

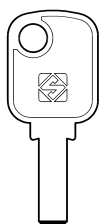

SCU1
SECURITAL

OPTIONAL



D729845ZB

A18 adapter
Adattatore A18
Adapter A18
Adaptateur A18
Adaptador A18
Adaptador A18

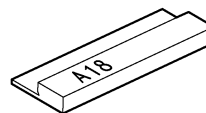

STANDARD



D943253ZR

01J Jaw
Ganascia 01J
01J Backe
Mâchoire 01J
Quijada 01J
Garra 01J

STANDARD



D943254ZR

02J Jaw
Ganascia 02J
02J Backe
Mâchoire 02J
Quijada 02J
Garra 02J

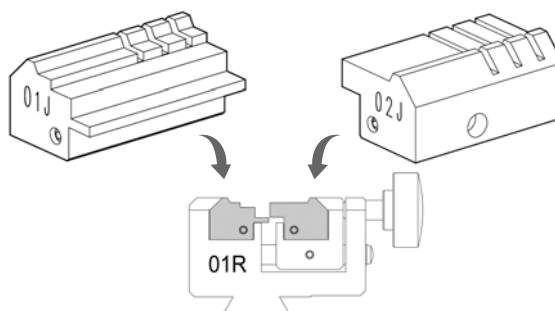

STANDARD



D742867ZB

Cutter 01D
Fresa 01D
Fräser 01D
Fraise 01D
Fresa 01D
Fresa 01D

PER:
FOR:

MAGNUM (GB)

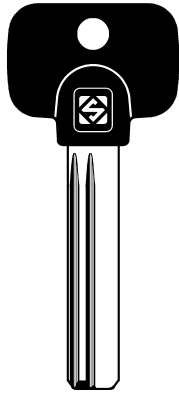

MGN1RP

Magnum Superior
(5+4) (4+3) (3+2)

Magnum Superior +
(5+4) (4+3) (3+2)

OPTIONAL D744363ZB

CODE
35J Jaw
Ganascia 35J
35J Backe
Mâchoire 35J
Quijada 35J
Garra 35J

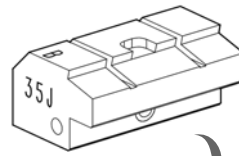

OPTIONAL D744365ZB

CODE
36J Jaw
Ganascia 36J
36J Backe
Mâchoire 36J
Quijada 36J
Garra 36J

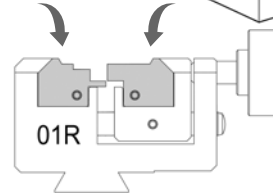
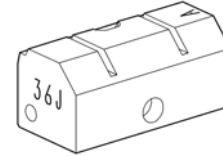

OPTIONAL



D743673ZB

Cutter 02D
Fresa 02D
Fräser 02D
Fraise 02D
Fresa 02D
Fresa 02D

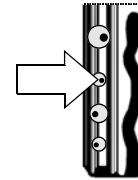

STANDARD D943253ZR

CODE
01J Jaw
Ganascia 01J
01J Backe
Mâchoire 01J
Quijada 01J
Garra 01J

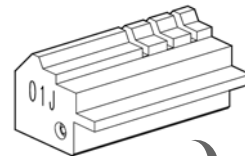

STANDARD D943254ZR

CODE
02J Jaw
Ganascia 02J
02J Backe
Mâchoire 02J
Quijada 02J
Garra 02J

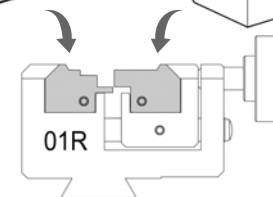
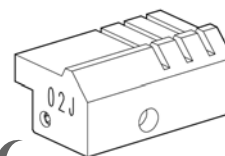

OPTIONAL



D743745ZB

Cutter 04L
Fresa 04L
Fräser 04L
Fraise 04L
Fresa 04L
Fresa 04L

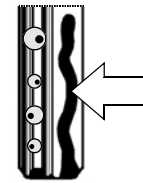

PER:
FOR: **MAUER (BG)**



(NW4)

OPTIONAL



D745192ZB

54J Jaw
Ganascia 54J
54J Backe
Mâchoire 54J
Quijada 54J
Garra 54J

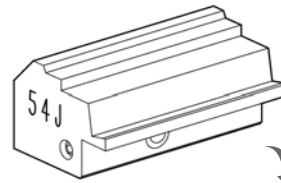

OPTIONAL



D745194ZB

55J Jaw
Ganascia 55J
55J Backe
Mâchoire 55J
Quijada 55J
Garra 55J

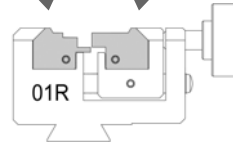
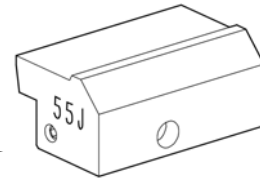

OPTIONAL



D743673ZB

Cutter 02D
Fresa 02D
Fräser 02D
Fraise 02D
Fresa 02D
Fresa 02D

PER:
FOR: **M&C (RO)**

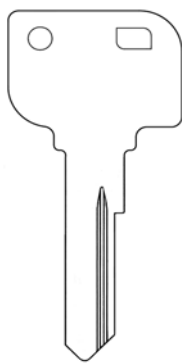

Matrix

OPTIONAL



D747169ZB

66J Jaw
Ganascia 66J
66J Backe
Mâchoire 66J
Quijada 66J
Garra 66J

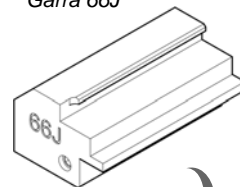

OPTIONAL



D747171ZB

67J Jaw
Ganascia 67J
67J Backe
Mâchoire 67J
Quijada 67J
Garra 67J

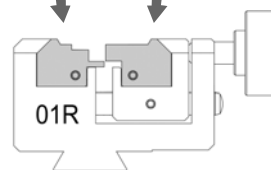
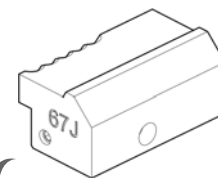

OPTIONAL

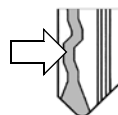

D743744ZB

Cutter 05L
Fresa 05L
Fräser 05L
Fraise 05L
Fresa 05L
Fresa 05L

System protected by a password issued by Silca on receipt of authorization.

Sistema protetto da password rilasciata da Silca a fronte di autorizzazione.

Sysyem geschützt durch von Silca geliefertes Password auf Genehmigung.

Système protégé par un password qui est émis par Silca sur autorisation.

Sistema protegido con contraseña que manda Silca previa autorización.

Sistema protegido por uma password emitida por Silca contra a autorização.

Note: standard cutting is also required.
Nota: è necessaria anche la cifratura standard.
Hinweis: Standard Fräsung ist auch erforderlich.
Remarque: il faut aussi nécessaire le taillage standard.
Nota: también es necesario el corte estándar.
Observação: o corte standard es também necessário

PER:
FOR:

M&C (RO)

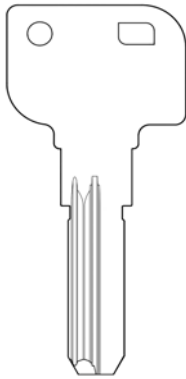

Color New
(3+3)
(2T-5W)

System protected by a password issued by Silca on receipt of authorization.

Sistema protetto da password rilasciata da Silca a fronte di autorizzazione.

Passwort geschütztes System - Freigabe des Herstellers erforderlich.

Système protégé par un password qui est émis par Silca sur autorisation.

Sistema protegido con contraseña que manda Silca previa autorización.

Sistema protegido por uma password emitida por Silca contra a autorização.

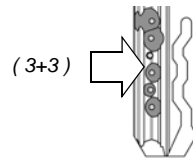

OPTIONAL D751453ZB

• CODE
◊ COPY
95J Jaw
Ganascia 95J
95J Backe
Mâchoire 95J
Quijada 95J
Garra 95J

OPTIONAL D751455ZB

• CODE
◊ COPY
96J Jaw
Ganascia 96J
96J Backe
Mâchoire 96J
Quijada 96J
Garra 96J

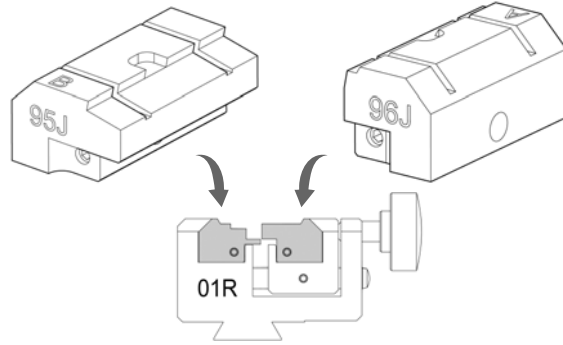

STANDARD

01D
D742867ZB
Cutter 01D
Fresa 01D
Fräser 01D
Fraise 01D
Fresa 01D
Fresa 01D

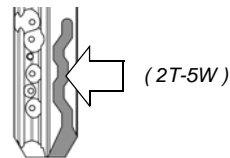

STANDARD D943253ZR

• CODE
◊ COPY
01J Jaw
Ganascia 01J
01J Backe
Mâchoire 01J
Quijada 01J
Garra 01J

STANDARD D943254ZR

• CODE
◊ COPY
02J Jaw
Ganascia 02J
02J Backe
Mâchoire 02J
Quijada 02J
Garra 02J

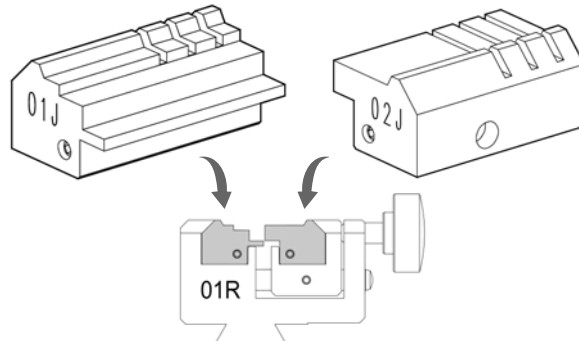

OPTIONAL

04L
D743745ZB
Cutter 04L
Fresa 04L
Fräser 04L
Fraise 04L
Fresa 04L
Fresa 04L

PER:
FOR:

M&C (RO)

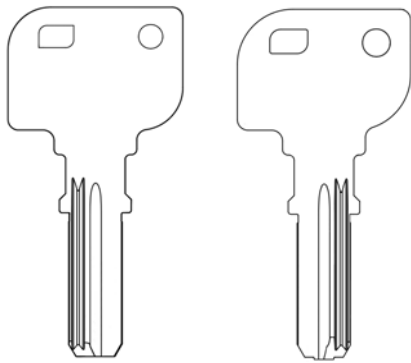

Condor

Condor Mirror

System protected by a password issued by Silca on receipt of authorization.

Sistema protetto da password rilasciata da Silca a fronte di autorizzazione.

System geschützt durch von Silca geliefertes Password auf Genehmigung.

Système protégé par un password qui est émis par Silca sur autorisation.

Sistema protegido con contraseña que manda Silca previa autorización.

Sistema protegido por uma password emitida por Silca contra a autorização.

OPTIONAL

D752826ZB

104 Jaw
Ganascia 104
104 Backe
Mâchoire 104
Quijada 104
Garra 104



OPTIONAL

D752828ZB

105 Jaw
Ganascia 105
105 Backe
Mâchoire 105
Quijada 105
Garra 105

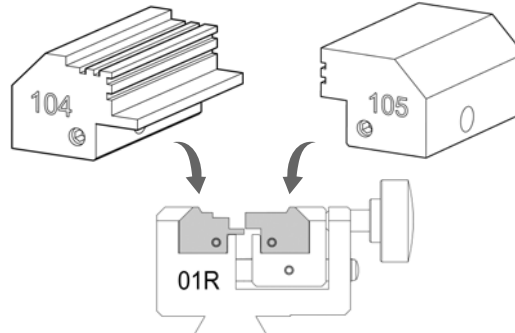

STANDARD

D742867ZB

Cutter 01D
Fresa 01D
Fräser 01D
Fraise 01D
Fresa 01D
Fresa 01D

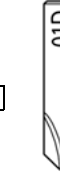
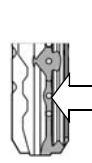

STANDARD

D747838ZB

Cutter 01LW
Fresa 01LW
Fräser 01LW
Fraise 01LW
Fresa 01LW
Fresa 01LW

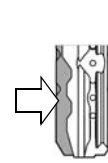

PER:
FOR:

MERONI (I)

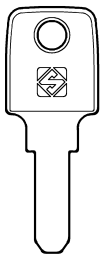

MER39
M4

OPTIONAL

D743343ZB

14J Jaw
Ganascia 14J
14J Backe
Mâchoire 14J
Quijada 14J
Garra 14J



OPTIONAL

D743361ZB

15J Jaw
Ganascia 15J
15J Backe
Mâchoire 15J
Quijada 15J
Garra 15J

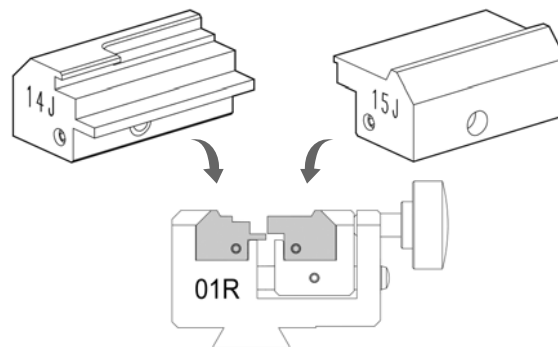

OPTIONAL

D747839ZB

Cutter 02LW
Fresa 02LW
Fräser 02LW
Fraise 02LW
Fresa 02LW
Fresa 02LW



OPTIONAL

D743671ZB

Cutter 02L
Fresa 02L
Fräser 02L
Fraise 02L
Fresa 02L
Fresa 02L



PER:
FOR:

MG MONTI (I)

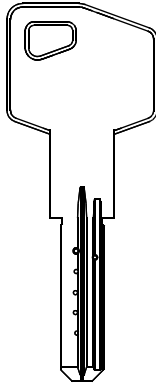

(HSP)

System protected by a password issued by Silca on receipt of authorization.

Sistema protetto da password rilasciata da Silca a fronte di autorizzazione.

System geschützt durch von Silca geliefertes Passwort auf Genehmigung.

Système protégé par un password qui est émis par Silca sur autorisation.

Sistema protegido con contraseña que manda Silca previa autorización.

Sistema protegido por uma password emitida por Silca contra a autorização.

OPTIONAL



D744491ZB

42J Jaw
Ganascia 42J
42J Backe
Mâchoire 42J
Quijada 42J
Garra 42J



OPTIONAL



D744493ZB

43J Jaw
Ganascia 43J
43J Backe
Mâchoire 43J
Quijada 43J
Garra 43J

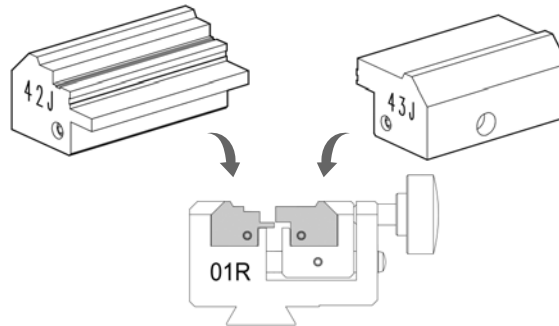

STANDARD



D742867B

Cutter 01D
Fresa 01D
Fräser 01D
Fraise 01D
Fresa 01D
Fresa 01D

PER:
FOR:

MUL.T.LOCK (IL)

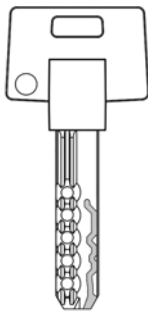

MT5 + (L)
MT5 + (R)

STANDARD



D943253ZR

01J Jaw
Ganascia 01J
01J Backe
Mâchoire 01J
Quijada 01J
Garra 01J



STANDARD



D943254ZR

02J Jaw
Ganascia 02J
02J Backe
Mâchoire 02J
Quijada 02J
Garra 02J

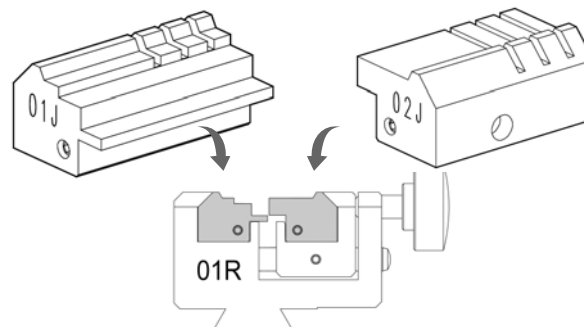

OPTIONAL



D745913ZB

Tracer point 05T
Tastatore 05T
Taster 05T
Palpeur 05T
Palpador 05T
Palpador 05T

OPTIONAL

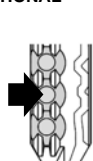

D743746ZB

Cutter 04D
Fresa 04D
Fräser 04D
Fraise 04D
Fresa 04D
Fresa 04D

OPTIONAL

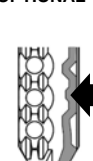

D743744ZB

Cutter 05L
Fresa 05L
Fräser 05L
Fraise 05L
Fresa 05L
Fresa 05L

PER:
FOR: **PFAFFENHAIN (D)**

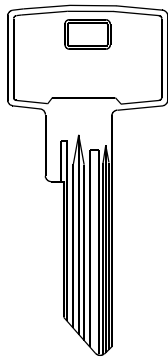

(K14)

OPTIONAL



D744309ZB

24J Jaw
Ganascia 24J
24J Backe
Mâchoire 24J
Quijada 24J
Garra 24J



OPTIONAL



D744311ZB

25J Jaw
Ganascia 25J
25J Backe
Mâchoire 25J
Quijada 25J
Garra 25J

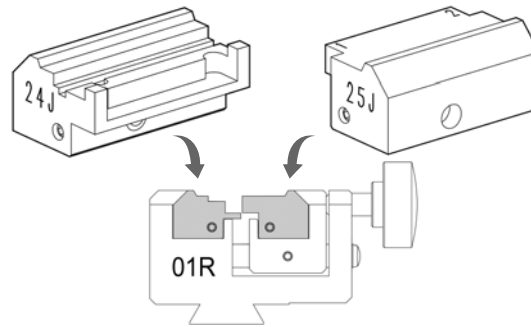

STANDARD



D742867ZB

Cutter 01D
Fresa 01D
Fräser 01D
Fraise 01D
Fresa 01D
Fresa 01D

STANDARD



D942846ZR

01V clamp
Morsetto 01V
Spannbacke 01V
Etau 01V
Mordaza 01V
Mordente 01V

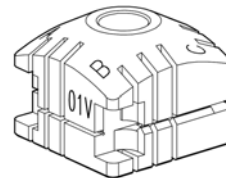

PER:
FOR: **PFAFFENHAIN (D)**

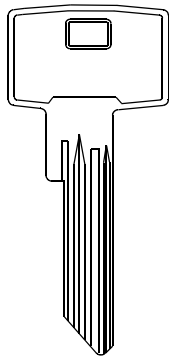

(KV14 - XY14)

(KV14 - XV14)

OPTIONAL



D744313ZB

28J Jaw
Ganascia 28J
28J Backe
Mâchoire 28J
Quijada 28J
Garra 28J



OPTIONAL



D744311ZB

25J Jaw
Ganascia 25J
25J Backe
Mâchoire 25J
Quijada 25J
Garra 25J

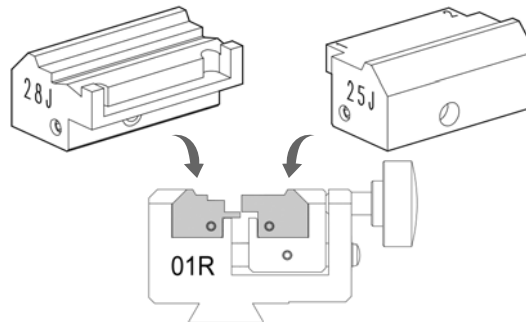

STANDARD



D742867ZB

Cutter 01D
Fresa 01D
Fräser 01D
Fraise 01D
Fresa 01D
Fresa 01D

OPTIONAL



D744373ZB

Clamp 04V
Morsetto 04V
Spannbacke 04V
Etau 04V
Mordaza 04V
Mordente 04V

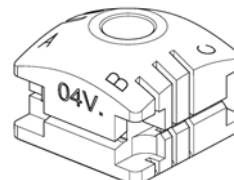

PER:
FOR:

SECUREMME (I)

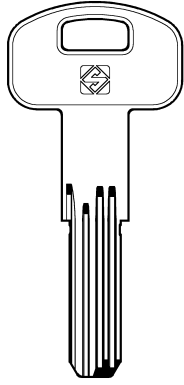

SCM2
K1

OPTIONAL



D743341ZB

13J Jaw
Ganascia 13J
13J Backe
Mâchoire 13J
Quijada 13J
Garra 13J

STANDARD



D943254ZR

02J Jaw
Ganascia 02J
02J Backe
Mâchoire 02J
Quijada 02J
Garra 02J

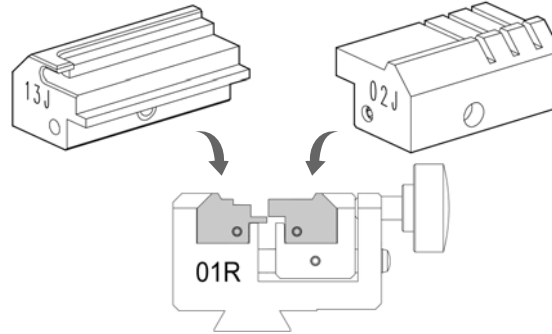

OPTIONAL



D743673ZB

Cutter 02D
Fresa 02D
Fräser 02D
Fraise 02D
Fresa 02D
Fresa 02D

PER:
FOR:

SECUREMME (I)

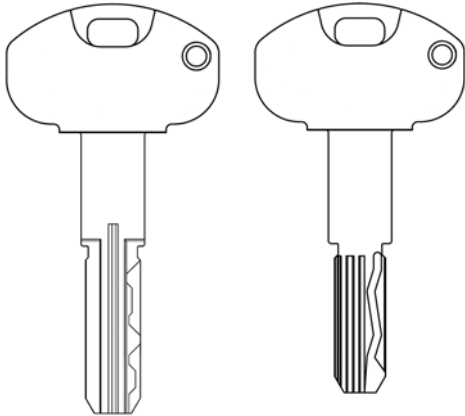

(K3)
5 pin

(K3)
5+5 pin

OPTIONAL



D743261ZB

05J Jaw
Ganascia 05J
05J Backe
Mâchoire 05J
Quijada 05J
Garra 05J

D743262ZB

06J Jaw
Ganascia 06J
06J Backe
Mâchoire 06J
Quijada 06J
Garra 06J

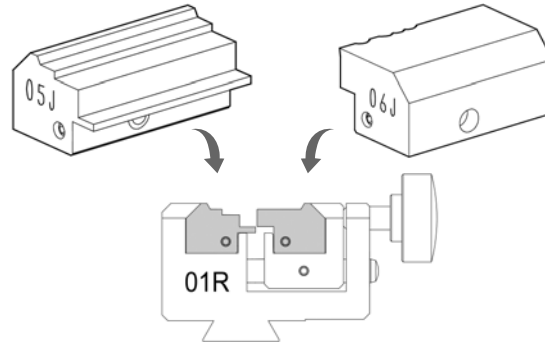

OPTIONAL



D743673ZB

Cutter 02D
Fresa 02D
Fräser 02D
Fraise 02D
Fresa 02D
Fresa 02D

PER:
FOR: **SECUREMME (I)**

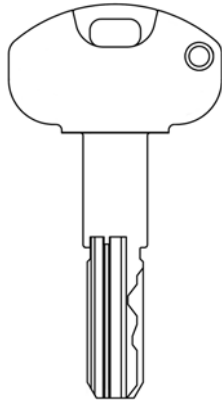

(K5)

6 pin

System protected by a password issued by Silca on receipt of authorization.

Sistema protetto da password rilasciata da Silca a fronte di autorizzazione.

System geschützt durch von Silca geliefertes Password auf Genehmigung.

Système protégé par un password qui est émis par Silca sur autorisation.

Sistema protegido con contraseña que manda Silca previa autorización.

Sistema protegido por uma password emitida por Silca contra a autorização.

OPTIONAL **D744017ZB**



18J Jaw
Ganascia 18J
18J Backe
Mâchoire 18J
Quijada 18J
Garra 18J

STANDARD **D943254ZR**



02J Jaw
Ganascia 02J
02J Backe
Mâchoire 02J
Quijada 02J
Garra 02J

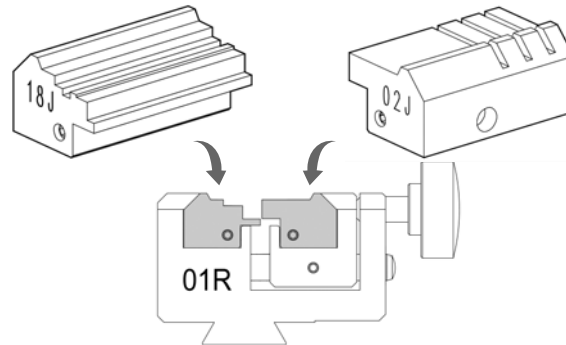

OPTIONAL



D743673ZB

Cutter 02D
Fresa 02D
Fräser 02D
Fraise 02D
Fresa 02D
Fresa 02D

PER:
FOR: **SECUREMME (I)**

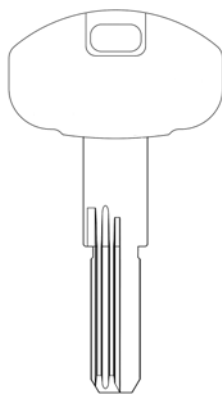

EVO K22 (11 pin)

EVO K64 (10 pin) (11 pin)

System protected by a password issued by Silca on receipt of authorization.

Sistema protetto da password rilasciata da Silca a fronte di autorizzazione.

System geschützt durch von Silca geliefertes Password auf Genehmigung.

Système protégé par un password qui est émis par Silca sur autorisation.

Sistema protegido con contraseña que manda Silca previa autorización.

Sistema protegido por uma password emitida por Silca contra a autorização.

OPTIONAL **D743341ZB**



13J Jaw
Ganascia 13J
13J Backe
Mâchoire 13J
Quijada 13J
Garra 13J

STANDARD **D943254ZR**



02J Jaw
Ganascia 02J
02J Backe
Mâchoire 02J
Quijada 02J
Garra 02J

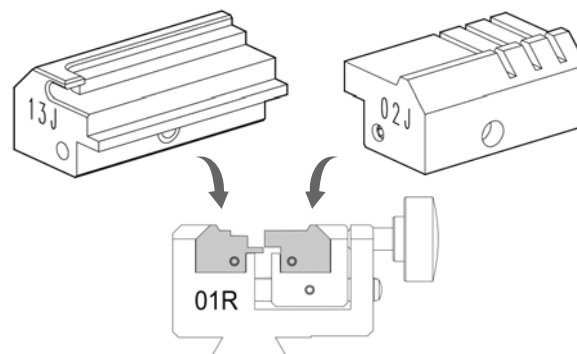

OPTIONAL



D747004ZB

Cutter 14D
Fresa 14D
Fräser 14D
Fraise 14D
Fresa 14D
Fresa 14D

PER:
FOR:

STS (E)

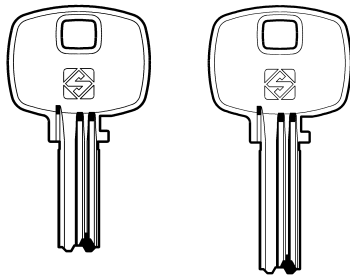

STS5

STS6

OPTIONAL



D743340ZB

12J Jaw
Ganascia 12J
12J Backe
Mâchoire 12J
Quijada 12J
Garra 12J

STANDARD



D943254ZR

02J Jaw
Ganascia 02J
02J Backe
Mâchoire 02J
Quijada 02J
Garra 02J

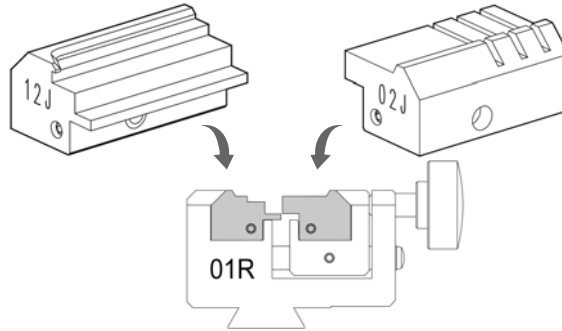

STANDARD



D742867ZB

Cutter 01D
Fresa 01D
Fräser 01D
Fraise 01D
Fresa 01D
Fresa 01D

PER:
FOR:

STS (E)

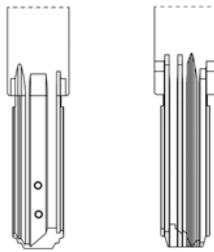

(ST6)

(ST8)

SYSTEM	CARD	SN
ST6	2986	1131
ST8	3006	1151

OPTIONAL



D746544ZB

58J Jaw
Ganascia 58J
58J Backe
Mâchoire 58J
Quijada 58J
Garra 58J

OPTIONAL



D746839ZB

61J Jaw
Ganascia 61J
61J Backe
Mâchoire 61J
Quijada 61J
Garra 61J

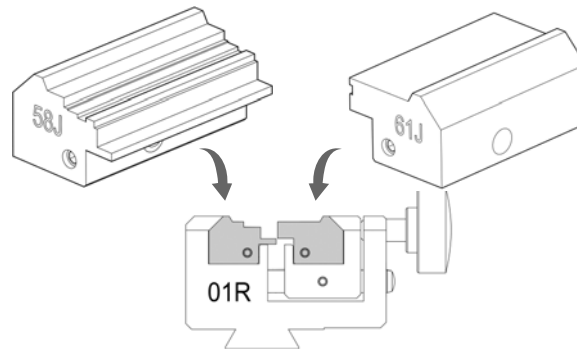

OPTIONAL



D744508ZB

Cutter 09D
Fresa 09D
Fräser 09D
Fraise 09D
Fresa 09D
Fresa 09D

System protected by a password issued by Silca on receipt of authorization.

Sistema protetto da password rilasciata da Silca a fronte di autorizzazione.

System geschützt durch von Silca geliefertes Password auf Genehmigung.

Système protégé par un password qui est émis par Silca sur autorisation.

Sistema protegido con contraseña que manda Silca previa autorización.

Sistema protegido por uma password emitida por Silca contra a autorização.

PER:
FOR:

TESA (E)

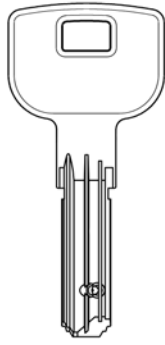

(TX70)

System protected by a password issued by Silca on receipt of authorization.

Sistema protetto da password rilasciata da Silca a fronte di autorizzazione.

Passwort geschütztes System - Freigabe des Herstellers erforderlich.

Système protégé par un password qui est émis par Silca sur autorisation.

Sistema protegido con contraseña que manda Silca previa autorización.

Sistema protegido por uma password emitida por Silca contra a autorização.

OPTIONAL D751338ZB

- CODE 94J Jaw
- CODE Ganascia 94J
- ◊ COPY 94J Backe
- ◊ COPY Mâchoire 94J
- ◊ COPY Quijada 94J
- ◊ COPY Garra 94J

OPTIONAL D748361ZB

- CODE 83J Jaw
- CODE Ganascia 83J
- ◊ COPY 83J Backe
- ◊ COPY Mâchoire 83J
- ◊ COPY Quijada 83J
- ◊ COPY Garra 83J

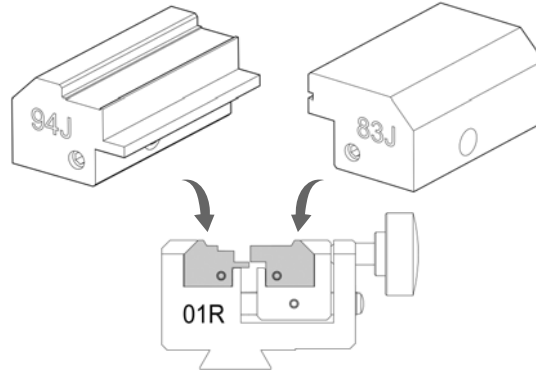

STANDARD

D742867ZB

- Cutter 01D
- Fresa 01D
- Fräser 01D
- Fraise 01D
- Fresa 01D
- Fresa 01D



PER:
FOR:

VACHETTE (F)

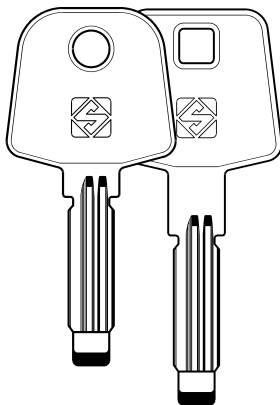

VAC91 VAC104

VAC103 VAC105

(VACHETTE RADIAL)

OPTIONAL

D744287ZB

- CODE 22J Jaw
- CODE Ganascia 22J
- ◊ COPY 22J Backe
- ◊ COPY Mâchoire 22J
- ◊ COPY Quijada 22J
- ◊ COPY Garra 22J

OPTIONAL D744288ZB

- CODE 23J Jaw
- CODE Ganascia 23J
- ◊ COPY 23J Backe
- ◊ COPY Mâchoire 23J
- ◊ COPY Quijada 23J
- ◊ COPY Garra 23J

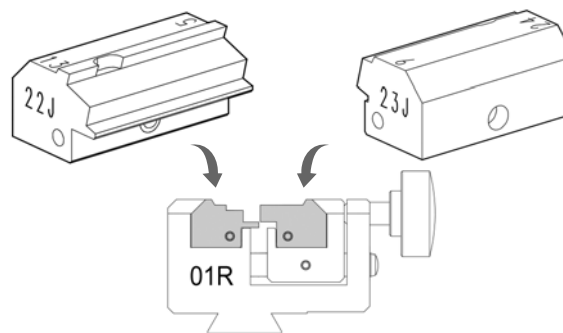

OPTIONAL

D743674ZB

- Cutter 03D
- Fresa 03D
- Fräser 03D
- Fraise 03D
- Fresa 03D
- Fresa 03D



PER:
FOR:

VIRO (I)



(Palladium)

System protected by a password issued by Silca on receipt of authorization.

Sistema protetto da password rilasciata da Silca a fronte di autorizzazione.

System geschützt durch von Silca geliefertes Password auf Genehmigung.

Système protégé par un password qui est émis par Silca sur autorisation.

Sistema protegido con contraseña que manda Silca previa autorización.

Sistema protegido por uma password emitida por Silca contra a autorização.

OPTIONAL



D744560ZB

50J Jaw
Ganascia 50J
50J Backe
Mâchoire 50J
Quijada 50J
Garra 50J



OPTIONAL



D744634ZB

51J Jaw
Ganascia 51J
51J Backe
Mâchoire 51J
Quijada 51J
Garra 51J

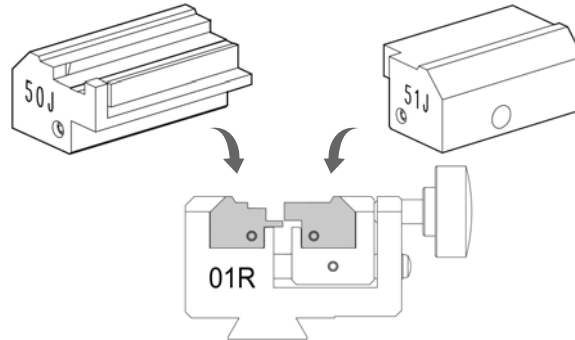

OPTIONAL



D743673ZB

Cutter 02D
Fresa 02D
Fräser 02D
Fraise 02D
Fresa 02D
Fresa 02D

PER:
FOR:

WILKA (D)



(PR100)
(Carat - P1)

OPTIONAL



D744309ZB

24J Jaw
Ganascia 24J
24J Backe
Mâchoire 24J
Quijada 24J
Garra 24J



OPTIONAL



D744311ZB

25J Jaw
Ganascia 25J
25J Backe
Mâchoire 25J
Quijada 25J
Garra 25J

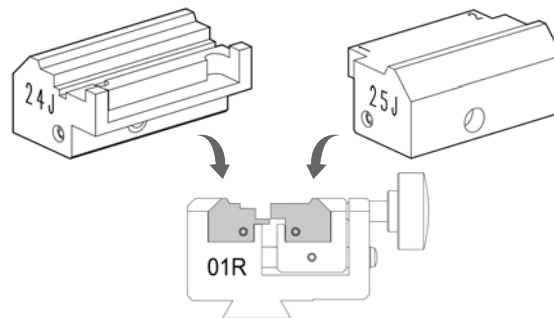

OPTIONAL



D743673ZB

Cutter 02D
Fresa 02D
Fräser 02D
Fraise 02D
Fresa 02D
Fresa 02D

PER:
FOR:

WILKA (D)

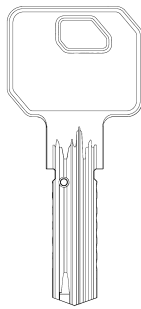

(PR300)
(Carat - P3)

OPTIONAL D744503ZB

- CODE 48J Jaw
- CODE Ganascia 48J
- ◊ COPY 48J Backe
- ◊ COPY Mâchoire 48J
- ◊ COPY Quijada 48J
- ◊ COPY Garra 48J

OPTIONAL D744501ZB

- CODE 47J Jaw
- CODE Ganascia 47J
- ◊ COPY 47J Backe
- ◊ COPY Mâchoire 47J
- ◊ COPY Quijada 47J
- ◊ COPY Garra 47J

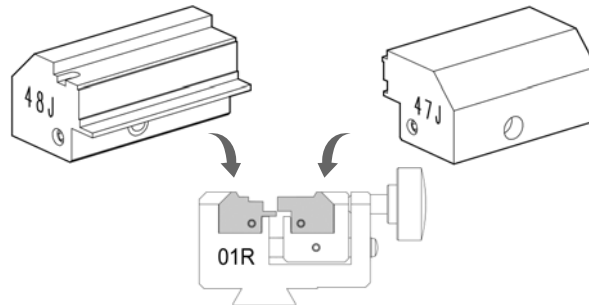

STANDARD



D742867ZB

- Cutter 01D
- Fresa 01D
- Fräser 01D
- Fraise 01D
- Fresa 01D
- Fresa 01D

PER:
FOR:

WILKA (D)

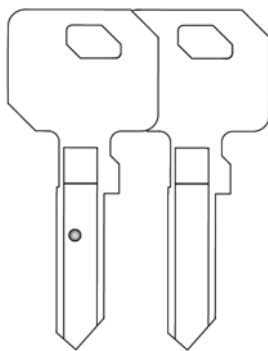

(Carat S1 - Carat S4)

DIMPLE CUTS

SYSTEM	CARD	SN
Carat S1	4358	1980
Carat S4	4358	1986

STANDARD CUTS

SYSTEM	CARD	SN
Carat S1	4357	4838
Carat S4	4357	4839

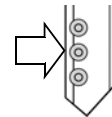

OPTIONAL D747173ZB

- CODE 68J jaw
- CODE Ganascia 68J
- ◊ COPY 68J Backe
- ◊ COPY Mâchoire 68J
- ◊ COPY Quijada 68J
- ◊ COPY Garra 68J

OPTIONAL D747175ZB

- CODE 69J jaw
- CODE Ganascia 69J
- ◊ COPY 69J Backe
- ◊ COPY Mâchoire 69J
- ◊ COPY Quijada 69J
- ◊ COPY Garra 69J

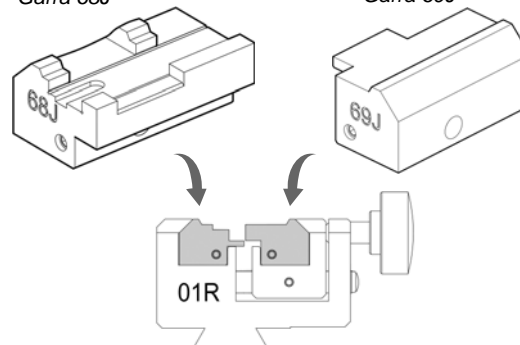

OPTIONAL



D743673ZB

- Cutter 02D
- Fresa 02D
- Fräser 02D
- Fraise 02D
- Fresa 02D
- Fresa 02D

OPTIONAL

- CODE
- ◊ COPY

D752566ZB

- B16 adapter
- Adattatore B16
- B16 Adapter
- Adaptateur B16
- Adaptador B16
- Adaptador B16

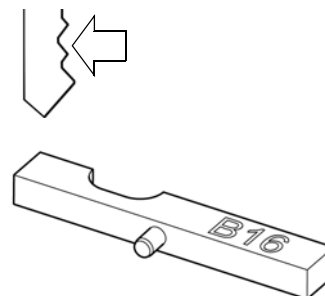

PER:
FOR:

WINKHAUS (D)

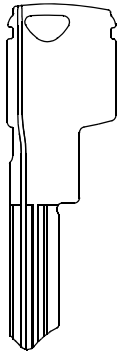

(RPE - RPS)

System protected by a password issued by Silca on receipt of authorization.

Sistema protetto da password rilasciata da Silca a fronte di autorizzazione.

System geschützt durch von Silca geliefertes Password auf Genehmigung.

Système protégé par un password qui est émis par Silca sur autorisation.

Sistema protegido con contraseña que manda Silca previa autorización.

Sistema protegido por uma password emitida por Silca contra a autorização.

OPTIONAL



D744309ZB

24J Jaw
Ganascia 24J
24J Backe
Mâchoire 24J
Quijada 24J
Garra 24J



OPTIONAL



D744311ZB

25J Jaw
Ganascia 25J
25J Backe
Mâchoire 25J
Quijada 25J
Garra 25J

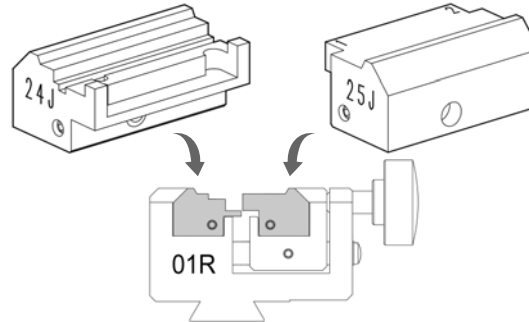

OPTIONAL



D744353ZB

Cutter 06D
Fresa 06D
Fräser 06D
Fraise 06D
Fresa 06D
Fresa 06D

OPTIONAL



D744369ZB

Clamp 03V
Morsetto 03V
Spannbacke 03V
Etau 03V
Mordaza 03V
Mordente 03V

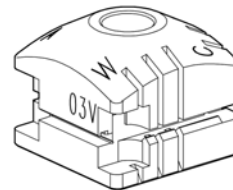



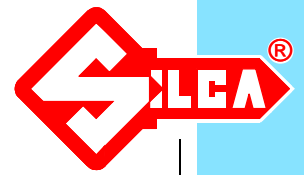







FUTURA PRO



PER:
FOR:

AUDI (D)
FORD (D)
PORSCHE (D)
SEAT (E)
SKODA (CZ)
VOLKSWAGEN (D)



		
HU66MH	HU66P	HU66AT5 HU66AT6
		
HU66EHP	HU66T5 HU66T6	
	HU66T10	HU66CT5
HU66FH	HU66T15	HU66DT5
	HU66T23	HU66CT6
	HU66T26	HU66BT1
HU75T	HU66T28	HU66BT15
	HU66TE	HU66BT28

HUF (D) - WITTE (D)

OPTIONAL



D744023ZB

19J Jaw
Ganascia 19J
19J Backe
Mâchoire 19J
Quijada 19J
Garra 19J



STANDARD



D943254ZR

02J Jaw
Ganascia 02J
02J Backe
Mâchoire 02J
Quijada 02J
Garra 02J

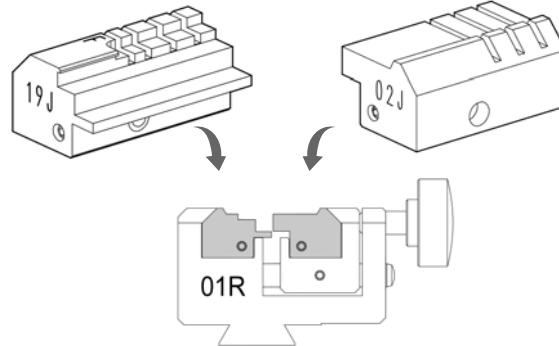

STANDARD



D747838ZB

Cutter 01LW
Fresa 01LW
Fräser 01LW
Fraise 01LW
Fresa 01LW
Fresa 01LW

OPTIONAL



D742606ZB

Cutter 01L
Fresa 01L
Fräser 01L
Fraise 01L
Fresa 01L
Fresa 01L



FUTURA PRO

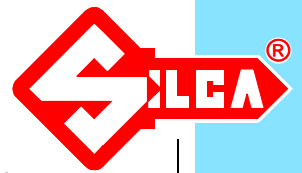

PER:
FOR:

BMW (D)

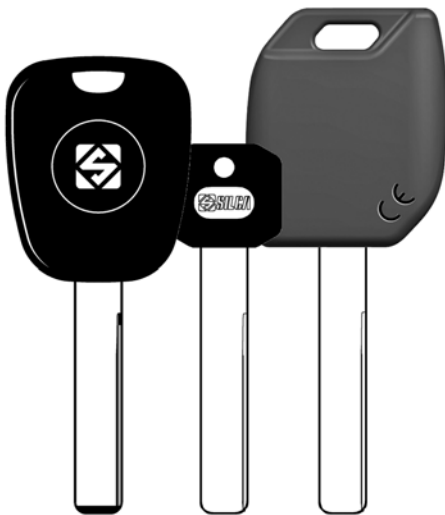

HU92RP **HU92RKP** **HU92RMH**

STANDARD



D943253ZR

01J Jaw
Ganascia 01J
01J Backe
Mâchoire 01J
Quijada 01J
Garra 01J

OPTIONAL



D743256ZB

04J Jaw
Ganascia 04J
04J Backe
Mâchoire 04J
Quijada 04J
Garra 04J

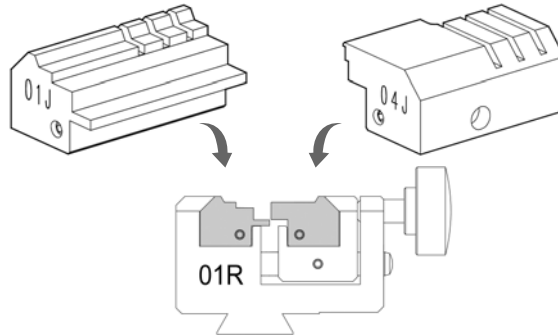

STANDARD



D747838ZB

Cutter 01LW
Fresa 01LW
Fräser 01LW
Fraise 01LW
Fresa 01LW
Fresa 01LW

OPTIONAL



D742606ZB

Cutter 01L
Fresa 01L
Fräser 01L
Fraise 01L
Fresa 01L
Fresa 01L

PER:
FOR:

CITROËN (F)



SX9CP **SX9GP** **SX9T14** **SX9MH**

SX9AP **SX9T6**
SX10BP
SX11BP **SX9TE**
SX9EHP

VALEO - SIMPLEX (F)

OPTIONAL

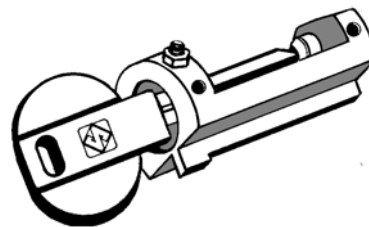

D708040ZB

Code adaptor B6 for SIMPLEX
Adattatore B6 a codice per chiavi SIMPLEX
Code-Adapter B6 für SIMPLEX Schlüssel
Adaptateur B6 à code pour clés SIMPLEX
Adaptador B6 a código para llaves SIMPLEX
Adaptador B6 por código para chaves SIMPLEX



FUTURA PRO

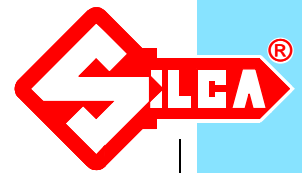

PER:
FOR:

FORD (D)

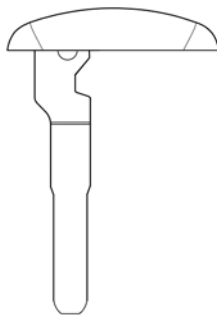

(Escape model)

OPTIONAL



D741485ZB

A34 adapter
Adattatore A34
Adapter A34
Adapteur A34
Adaptador A34

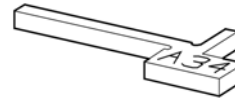

STANDARD



D943253ZR

01J Jaw
Ganascia 01J
01J Backe
Mâchoire 01J
Quijada 01J
Garra 01J



STANDARD



D943254ZR

02J Jaw
Ganascia 02J
02J Backe
Mâchoire 02J
Quijada 02J
Garra 02J

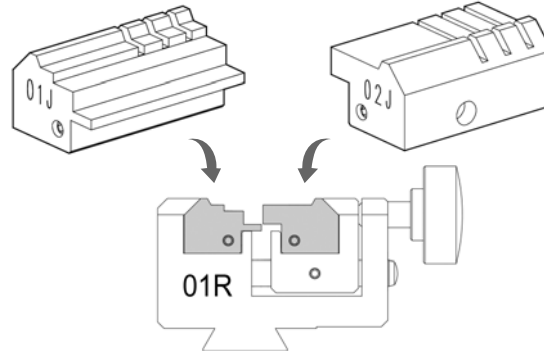

STANDARD



D747838ZB

Cutter 01LW
Fresa 01LW
Fräser 01LW
Fraise 01LW
Fresa 01LW
Fresa 01LW

OPTIONAL



D742606ZB

Cutter 01L
Fresa 01L
Fräser 01L
Fraise 01L
Fresa 01L
Fresa 01L

OR

OPTIONAL



D744023ZB

19J Jaw
Ganascia 19J
19J Backe
Mâchoire 19J
Quijada 19J
Garra 19J



STANDARD



D943254ZR

02J Jaw
Ganascia 02J
02J Backe
Mâchoire 02J
Quijada 02J
Garra 02J

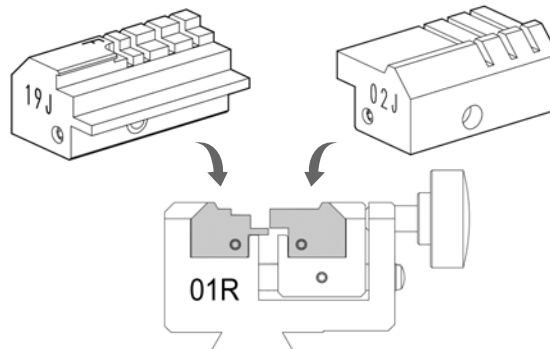

STANDARD



D747838ZB

Cutter 01LW
Fresa 01LW
Fräser 01LW
Fraise 01LW
Fresa 01LW
Fresa 01LW

OPTIONAL



D742606ZB

Cutter 01L
Fresa 01L
Fräser 01L
Fraise 01L
Fresa 01L
Fresa 01L



FUTURA PRO



PER:
FOR: **FORD (EU+USA)**

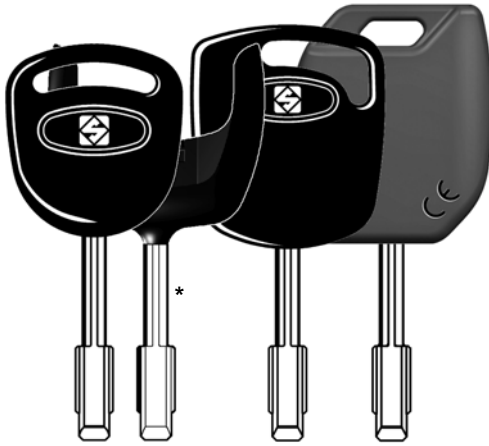

- FO21P FO21AP FO21T3 FO21MH
- FO21T3M
- FO21T7
- FO21EH1 FO21T17
- FO21EH2 FO21TE
- FO21FH

** IMPORTANT! Key blank to be applied to the original remote control (the remote control includes the transponder chip)*

TIBBE (D)
VALEO (F)

OPTIONAL

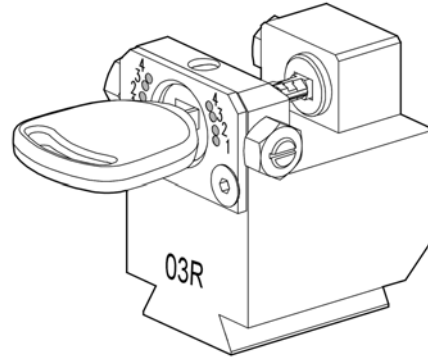

D743276ZB
03R Clamp
Morsetto 03R
03R Spannbacke
Etau 03R
Mordaza 03R
Mordente 03R

STANDARD



D747838ZB
Cutter 01LW
Fresa 01LW
Fräser 01LW
Fraise 01LW
Fresa 01LW
Fresa 01LW

OPTIONAL



D742606ZB
Cutter 01L
Fresa 01L
Fräser 01L
Fraise 01L
Fresa 01L
Fresa 01L

PER:
FOR: **HONDA (J)**

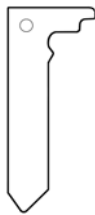

(N-BOX - N-ONE - N-VAGON)
Emergency key

OPTIONAL



D745037ZB
52J Jaw
Ganascia 52J
52J Backe
Mâchoire 52J
Quijada 52J
Garra 52J

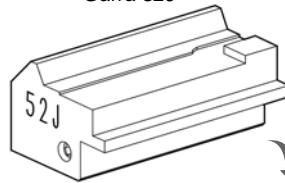

OPTIONAL



D745039ZB
53J Jaw
Ganascia 53J
53J Backe
Mâchoire 53J
Quijada 53J
Garra 53J

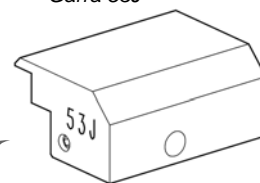

STANDARD



D747838ZB
Cutter 01LW
Fresa 01LW
Fräser 01LW
Fraise 01LW
Fresa 01LW
Fresa 01LW

OPTIONAL



D742606ZB
Cutter 01L
Fresa 01L
Fräser 01L
Fraise 01L
Fresa 01L
Fresa 01L



FUTURA PRO

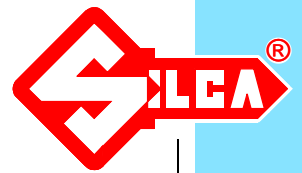

PER:
FOR:

HUF (D)

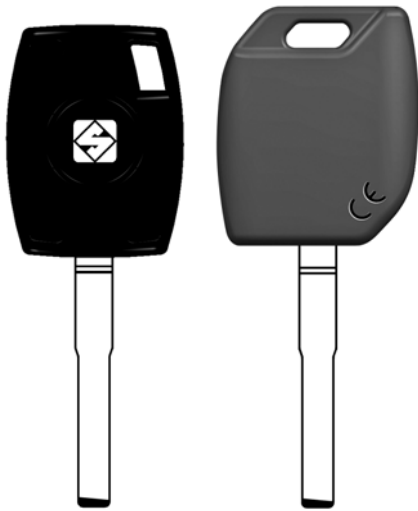

HU101T17
HU101T20
HU101TE

HU101MH

HU101T
HU101AP
HU101EH
HU101FH

OPTIONAL



D743255ZB

03J Jaw
Ganascia 03J
03J Backe
Mâchoire 03J
Quijada 03J
Garra 03J

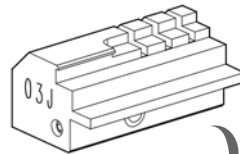

STANDARD



D943254ZR

02J Jaw
Ganascia 02J
02J Backe
Mâchoire 02J
Quijada 02J
Garra 02J

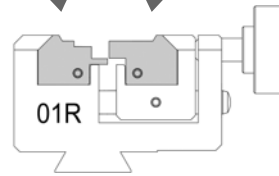
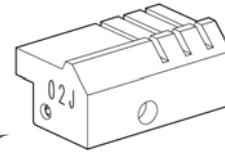

STANDARD



D747838ZB

Cutter 01LW
Fresa 01LW
Fräser 01LW
Fraise 01LW
Fresa 01LW
Fresa 01LW

OPTIONAL



D742606ZB

Cutter 01L
Fresa 01L
Fräser 01L
Fraise 01L
Fresa 01L
Fresa 01L

OR

OPTIONAL



D744023ZB

19J Jaw
Ganascia 19J
19J Backe
Mâchoire 19J
Quijada 19J
Garra 19J

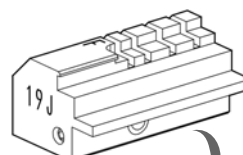

STANDARD



D943254ZR

02J Jaw
Ganascia 02J
02J Backe
Mâchoire 02J
Quijada 02J
Garra 02J

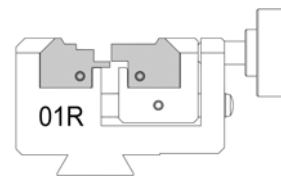
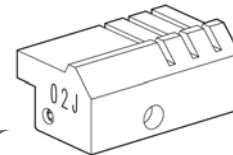

STANDARD



D747838ZB

Cutter 01LW
Fresa 01LW
Fräser 01LW
Fraise 01LW
Fresa 01LW
Fresa 01LW

OPTIONAL



D742606ZB

Cutter 01L
Fresa 01L
Fräser 01L
Fraise 01L
Fresa 01L
Fresa 01L



PER:
FOR:

HUF (D)



HU162T
(4T - 8W)

VOLKSWAGEN
SKODA

OPTIONAL

D746461ZB

56J Jaw
Ganascia 56J
56J Backe
Mâchoire 56J
Quijada 56J
Garra 56J

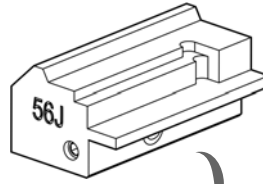

OPTIONAL

D746467ZB

57J Jaw
Ganascia 57J
57J Backe
Mâchoire 57J
Quijada 57J
Garra 57J

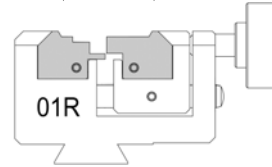
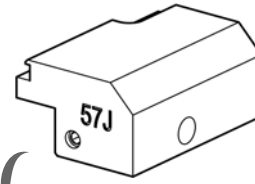

OPTIONAL

D747839ZB

Cutter 02LW
Fresa 02LW
Fräser 02LW
Fraise 02LW
Fresa 02LW
Fresa 02LW



OPTIONAL

D743671ZB

Cutter 02L
Fresa 02L
Fräser 02L
Fraise 02L
Fresa 02L
Fresa 02L



PER:
FOR:

MERCEDES (D)



HU41P

HU55P

HU64P

HU61AP

HU64T
HU65AP

HUF (D)

STANDARD

D943253ZR

01J Jaw
Ganascia 01J
01J Backe
Mâchoire 01J
Quijada 01J
Garra 01J

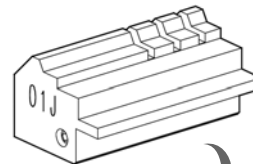

OPTIONAL

D743256ZB

04J Jaw
Ganascia 04J
04J Backe
Mâchoire 04J
Quijada 04J
Garra 04J

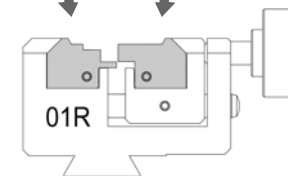
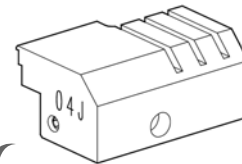

STANDARD

D747838ZB

Cutter 01LW
Fresa 01LW
Fräser 01LW
Fraise 01LW
Fresa 01LW
Fresa 01LW



OPTIONAL

D742606ZB

Cutter 01L
Fresa 01L
Fräser 01L
Fraise 01L
Fresa 01L
Fresa 01L



PER: **TUBULAR KEYS**
 FOR: **CHIAVI TUBOLARI**
STECKSCHLÜSSEL
CLÉS TUBULAIRES
LLAVES TUBOLARES

AGA (E)
BILMA (E) BIL1T

CHICAGO (USA) CH9T
 CH16T (9.2)
 CH17T (10)

L&F (GB)
KENSTAN (USA) CH9T

MERONI (I) MER22T (9.50)
 MER25T (9.50)

P.CORTELLEZZI (I) PC12T (9.60)
 PC12TP (9.60)
 PC15T (9.60)
 PC15TP (9.60)

SILCA (I) SLC1TP (9.60)
 SLC2TP (9.60)

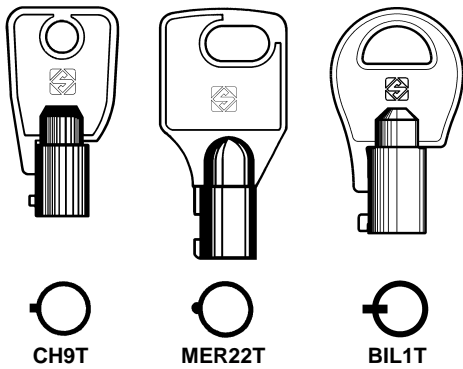

OPTIONAL



D743275ZB
 02R Clamp
 Morsetto 02R
 02R Spannbacke
 Etiau 02R
 Mordaza 02R
 Mordente 02R

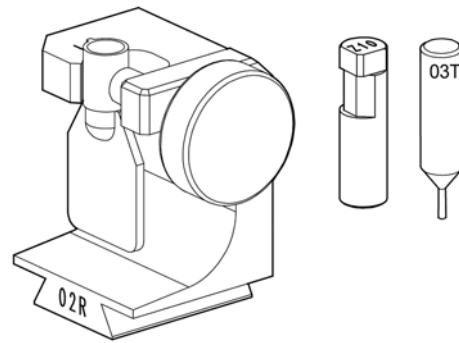

OPTIONAL



D743672ZB
 Cutter 03L
 Fresa 03L
 Fräser 03L
 Fraise 03L
 Fresa 03L
 Fresa 03L

PER: **ENGRAVING**
FOR:



FUTURA PRO
> SW 3.5.0

FUTURA
> SW 3.3.0

OPTIONAL
FUTURA PRO
FUTURA

STANDARD
FUTURA PRO ENGRAVING

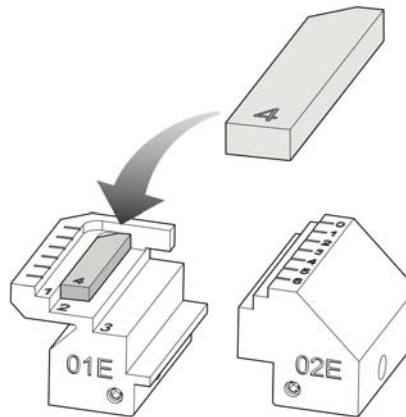

D750763ZB
Adapter plane 4
Adattatore sede 4
Adapter Ebene 4
Adaptateur emplacement 4
Adaptador alojamiento 4
Adaptador alojamento 4

D748737ZB
01E Jaw
Ganascia 01E
01E Backe
Mâchoire 01E
Quijada 01E
Garra 01E

D748739ZB
02E Jaw
Ganascia 02E
02E Backe
Mâchoire 02E
Quijada 02E
Garra 02E

D748741ZB
Cutter 18DW
Fresa 18DW
Fräser 18DW
Fraise 18DW
Fresa 18DW
Fresa 18DW

PLANE	WIDTH of the object to be engraved	ENGRAVING AREA (max.)
1	min 26 - max 32 mm	32 mm x 40 mm
2	min 20 - max 26 mm	24 mm x 36,5 mm
3	min 8 - max 14 mm	12 mm x 36,5 mm
4	min 14 - max 20 mm	18 mm x 36,5 mm

Thickness of the object to be engraved: max.5,2 mm

