

# SWIFT - SWIFT PLUS

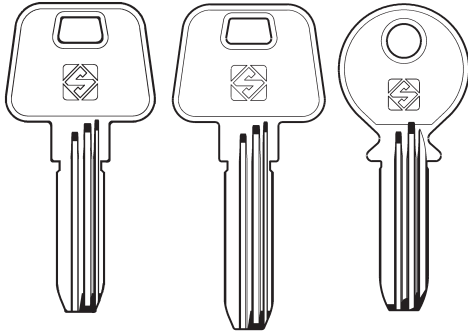

PER:  
FOR:

## AZBE (E)



AZ6

AZ7

AZ8

CAVERS (F)

STANDARD



for machines:  
**D749524ZB**  
**D749780ZB**

OPTIONAL



### D741446ZB

Tracer point TE11  
Tastatore TE11  
Taster TE11  
Palpeur TE11  
Palpador TE11  
Palpador TE11



### D749547ZB

Cutter FE11  
Fresa FE11  
Fräser FE11  
Fraise FE11  
Fresa FE11  
Fresa FE11

PER:  
FOR:

## CISA (I)

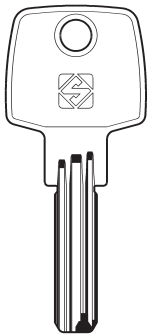

CS48

OPTIONAL



### D741430ZB

Tracer point TE03  
Tastatore TE03  
Taster TE03  
Palpeur TE03  
Palpador TE03  
Palpador TE03



### D741431ZB

Cutter FE03  
Fresa FE03  
Fräser FE03  
Fraise FE03  
Fresa FE03  
Fresa FE03

PER:  
FOR:

## ELZETT (H)

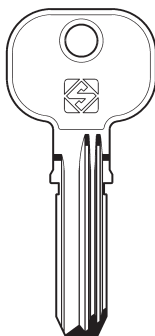

EL9

OPTIONAL



### D741430ZB

Tracer point TE03  
Tastatore TE03  
Taster TE03  
Palpeur TE03  
Palpador TE03  
Palpador TE03



### D741431ZB

Cutter FE03  
Fresa FE03  
Fräser FE03  
Fraise FE03  
Fresa FE03  
Fresa FE03



# SWIFT - SWIFT PLUS



PER:  
FOR: **FICHET (F)**

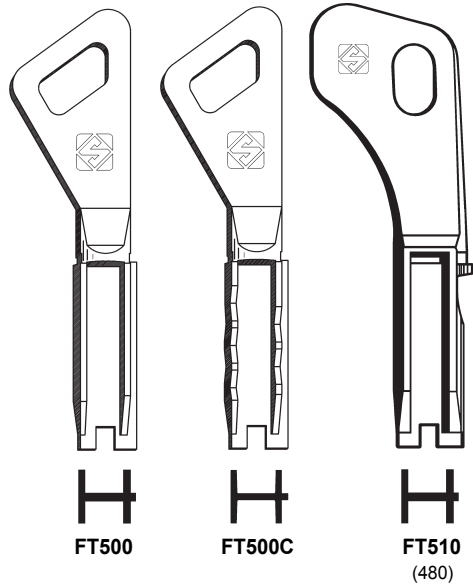

STANDARD



**D741432ZB**

Tracer point TE04  
Tastatore TE04  
Taster TE04  
Palpeur TE04  
Palpador TE04



**D749544ZB**

Cutter FE04  
Fresa FE04  
Fräser FE04  
Fraise FE04  
Fresa FE04

PER:  
FOR: **FTH (F)**

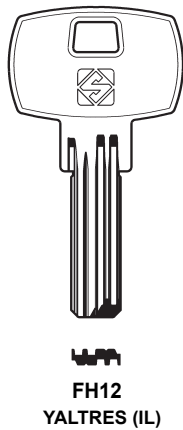

OPTIONAL



**D741430ZB**

Tracer point TE03  
Tastatore TE03  
Taster TE03  
Palpeur TE03  
Palpador TE03



**D741431ZB**

Cutter FE03  
Fresa FE03  
Fräser FE03  
Fraise FE03  
Fresa FE03

PER:  
FOR: **ISEO (I)**

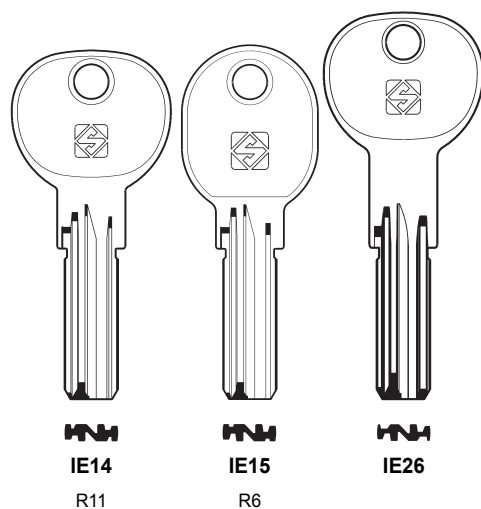

STANDARD



**D741128ZB**

Tracer point TE01  
Tastatore TE01  
Taster TE01  
Palpeur TE01  
Palpador TE01



**D749543ZB**

Cutter FE01  
Fresa FE01  
Fräser FE01  
Fraise FE01  
Fresa FE01



# SWIFT - SWIFT PLUS



PER:  
FOR:

## KABA (CH)

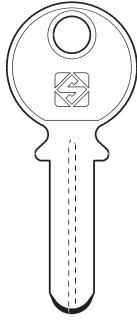

KA1

8

LÄSBOLAGET (S)

OPTIONAL



### D741430ZB

Tracer point TE03  
Tastatore TE03  
Taster TE03  
Palpeur TE03  
Palpador TE03  
Palpador TE03



### D741431ZB

Cutter FE03  
Fresa FE03  
Fräser FE03  
Fraise FE03  
Fresa FE03  
Fresa FE03

PER:  
FOR:

## MCM (E)

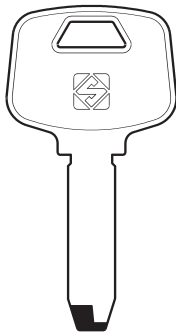

MC9

OPTIONAL



### D741442ZB

Tracer point TE09  
Tastatore TE09  
Taster TE09  
Palpeur TE09  
Palpador TE09  
Palpador TE09



### D741443ZB

Cutter FE09  
Fresa FE09  
Fräser FE09  
Fraise FE09  
Fresa FE09  
Fresa FE09

OPTIONAL



### D741444ZB

Tracer point TE10  
Tastatore TE10  
Taster TE10  
Palpeur TE10  
Palpador TE10  
Palpador TE10



### D741445ZB

Cutter FE10  
Fresa FE10  
Fräser FE10  
Fraise FE10  
Fresa FE10  
Fresa FE10

STANDARD



### D741128ZB

Tracer point TE01  
Tastatore TE01  
Taster TE01  
Palpeur TE01  
Palpador TE01  
Palpador TE01



### D749543ZB

Cutter FE01  
Fresa FE01  
Fräser FE01  
Fraise FE01  
Fresa FE01  
Fresa FE01



# SWIFT - SWIFT PLUS



PER:  
FOR: **MUL.T.LOCK (IL)**



**MTK13R**  
**MTK15R**  
 7X7  
**MTK13RAP**  
**MTK15RAP**  
 7X7 (66)

STANDARD      OPTIONAL



for machines:  
**D749524ZB**  
**D749780ZB**

**D741446ZB**  
Tracer point TE11  
Tastatore TE11  
Taster TE11  
Palpeur TE11  
Palpador TE11  
Palpador TE11



**D749547ZB**  
Cutter FE11  
Fresa FE11  
Fräser FE11  
Fraise FE11  
Fresa FE11  
Fresa FE11

PER:  
FOR: **MUL.T.LOCK (IL)**

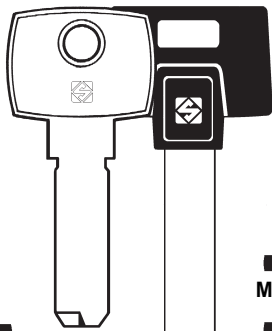

**MTK1**  
**MTK2P**  
**MTK3P**

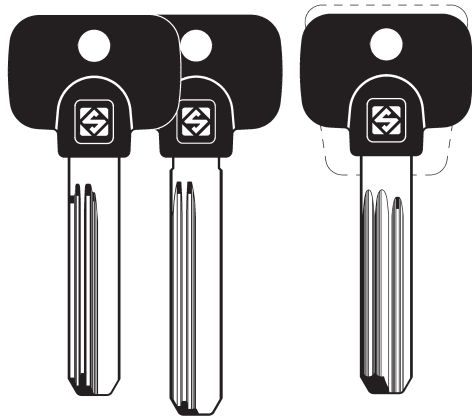

**MTK10RP**  
**MTK4RPX**  
**MTK12RP**  
 Junior  
**MTK4P**  
**MTK4RP**  
**MTK7RP**  
**MTK8RP**  
**MTK9RP**

STANDARD



STANDARD



for machines:  
**D749524ZB**  
**D749780ZB**

**D741128ZB**  
Tracer point TE01  
Tastatore TE01  
Taster TE01  
Palpeur TE01  
Palpador TE01  
Palpador TE01



**D749543ZB**  
Cutter FE01  
Fresa FE01  
Fräser FE01  
Fraise FE01  
Fresa FE01  
Fresa FE01

**D741440ZB**  
Tracer point TE08  
Tastatore TE08  
Taster TE08  
Palpeur TE08  
Palpador TE08  
Palpador TE08



**D749546ZB**  
Cutter FE08  
Fresa FE08  
Fräser FE08  
Fraise FE08  
Fresa FE08  
Fresa FE08



# SWIFT - SWIFT PLUS



PER:  
FOR: **MOTTURA (I)**

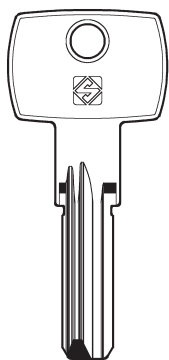

**GVY1R**

DEFENDER

STANDARD



for machines:  
**D749524ZB**  
**D749780ZB**

OPTIONAL



**D741446ZB**

Tracer point TE11  
Tastatore TE11  
Taster TE11  
Palpeur TE11  
Palpador TE11  
Palpador TE11



**D749547ZB**

Cutter FE11  
Fresa FE11  
Fräser FE11  
Fraise FE11  
Fresa FE11  
Fresa FE11

PER:  
FOR: **SEA (CH)**

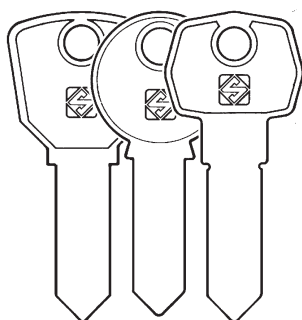

**SEB1 SEB2 SEB3**

SEA 23 SEA SEA 3  
SEA 20 SEA 2

EZCURRA (E)

STANDARD



for machines:  
**D749518ZB**  
**D749524ZB**

OPTIONAL



**D741448ZB**

Tracer point TE12  
Tastatore TE12  
Taster TE12  
Palpeur TE12  
Palpador TE12  
Palpador TE12



**D749548ZB**

Cutter FE12  
Fresa FE12  
Fräser FE12  
Fraise FE12  
Fresa FE12  
Fresa FE12

OPTIONAL



**D741430ZB**

Tracer point TE03  
Tastatore TE03  
Taster TE03  
Palpeur TE03  
Palpador TE03  
Palpador TE03



**D741431ZB**

Cutter FE03  
Fresa FE03  
Fräser FE03  
Fraise FE03  
Fresa FE03  
Fresa FE03

for SEB1 - SEB3 only  
solo per SEB1 - SEB3  
Nur für SEB1 - SEB3  
Seulement pour SEB1 - SEB3  
Solo para SEB1 - SEB3

PER:  
FOR: **SECURITAL (I)**

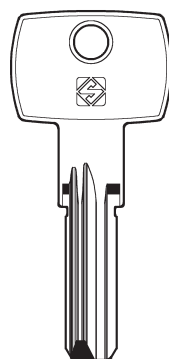

**GVY1R**

Psei

OPTIONAL



**D741436ZB**

Tracer point TE06  
Tastatore TE06  
Taster TE06  
Palpeur TE06  
Palpador TE06  
Palpador TE06



**D741437ZB**

Cutter FE06  
Fresa FE06  
Fräser FE06  
Fraise FE06  
Fresa FE06  
Fresa FE06



# SWIFT - SWIFT PLUS



PER:  
FOR:

## TESA (E)

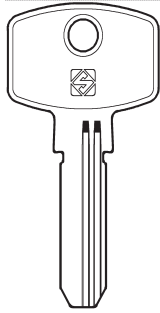

  
TE4  
T10

  
TE4R

### STANDARD



for machines:  
D749524ZB  
D749780ZB

### OPTIONAL



#### D741446ZB

Tracer point TE11  
Tastatore TE11  
Taster TE11  
Palpeur TE11  
Palpador TE11  
Palpador TE11



#### D749547ZB

Cutter FE11  
Fresa FE11  
Fräser FE11  
Fraise FE11  
Fresa FE11  
Fresa FE11

PER:  
FOR:

## TESA (E)

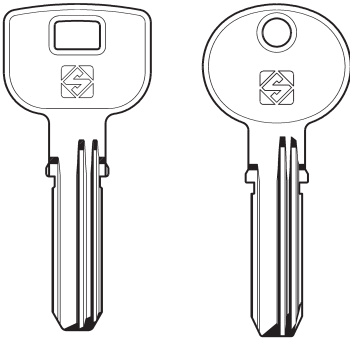

  
TE5  
T80

  
TE7  
T60

### OPTIONAL



#### D741430ZB

Tracer point TE03  
Tastatore TE03  
Taster TE03  
Palpeur TE03  
Palpador TE03  
Palpador TE03



#### D741431ZB

Cutter FE03  
Fresa FE03  
Fräser FE03  
Fraise FE03  
Fresa FE03  
Fresa FE03

PER:  
FOR:

## ZADI (I)

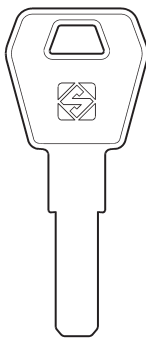

  
ZD25

### OPTIONAL



#### D741434ZB

Tracer point TE05  
Tastatore TE05  
Taster TE05  
Palpeur TE05  
Palpador TE05  
Palpador TE05



#### D741435ZB

Cutter FE05  
Fresa FE05  
Fräser FE05  
Fraise FE05  
Fresa FE05  
Fresa FE05



# SWIFT - SWIFT PLUS



PER:  
FOR:

**BMW (D)**

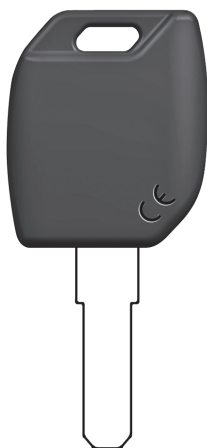

**BW9MH**

OPTIONAL



**D741434ZB**

Tracer point TE05  
Tastatore TE05  
Taster TE05  
Palpeur TE05  
Palpador TE05  
Palpador TE05



**D741435ZB**

Cutter FE05  
Fresa FE05  
Fräser FE05  
Fraise FE05  
Fresa FE05  
Fresa FE05

PER:  
FOR:

**FORD (EU + USA)**

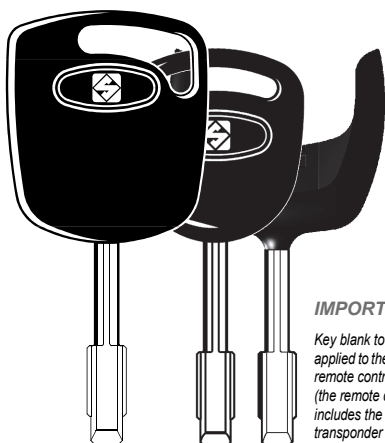

**IMPORTANT!**

Key blank to be applied to the original remote control (the remote control includes the transponder chip)

**FO21T3**

**FO21P**

**FO21AP**

**FO21T17**

TIBBE (D)  
VALEO (F)

OPTIONAL



**D741409ZB**

Code attachment  
Dispositivo a codice  
Code-Vorrichtung  
Dispositif à code  
Dispositivo a código  
Dispositivo por código

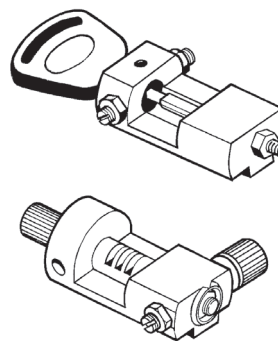

STANDARD

**D741432ZB**

Tracer point TE04  
Tastatore TE04  
Taster TE04  
Palpeur TE04  
Palpador TE04  
Palpador TE04



**D749544ZB**

Cutter FE04  
Fresa FE04  
Fräser FE04  
Fraise FE04  
Fresa FE04  
Fresa FE04

PER:  
FOR:

**HONDA (J)**

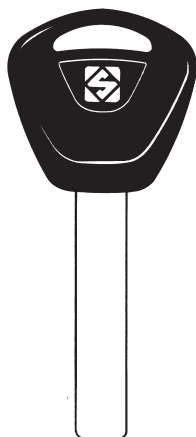

**HON60AP**  
ACURA (J)

OPTIONAL



**D741434ZB**

Tracer point TE05  
Tastatore TE05  
Taster TE05  
Palpeur TE05  
Palpador TE05  
Palpador TE05



**D741435ZB**

Cutter FE05  
Fresa FE05  
Fräser FE05  
Fraise FE05  
Fresa FE05  
Fresa FE05



# SWIFT - SWIFT PLUS



PER:  
FOR:

## HONDA (J)

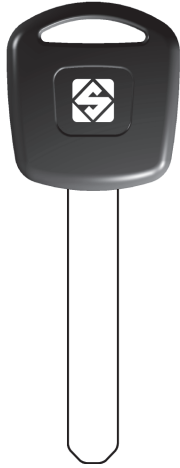

HON66GP

HON66T5  
HON66T6  
HON66T14  
HOV01T5

STANDARD



### D741432ZB

Tracer point TE04  
Tastatore TE04  
Taster TE04  
Palpeur TE04  
Palpador TE04  
Palpador TE04



### D749544ZB

Cutter FE04  
Fresa FE04  
Fräser FE04  
Fraise FE04  
Fresa FE04  
Fresa FE04

PER:  
FOR:

## HUF (D)



HU100T12

HU100T

HU100BT12

OPEL

HU100AT12

STANDARD



### D741432ZB

Tracer point TE04  
Tastatore TE04  
Taster TE04  
Palpeur TE04  
Palpador TE04  
Palpador TE04



### D749544ZB

Cutter FE04  
Fresa FE04  
Fräser FE04  
Fraise FE04  
Fresa FE04  
Fresa FE04

PER:  
FOR:

## HUF (D)

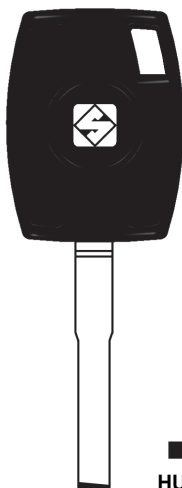

HU101...

STANDARD



### D741432ZB

Tracer point TE04  
Tastatore TE04  
Taster TE04  
Palpeur TE04  
Palpador TE04  
Palpador TE04



### D749544ZB

Cutter FE04  
Fresa FE04  
Fräser FE04  
Fraise FE04  
Fresa FE04  
Fresa FE04





# SWIFT - SWIFT PLUS



PER:  
FOR:

HUF (D)

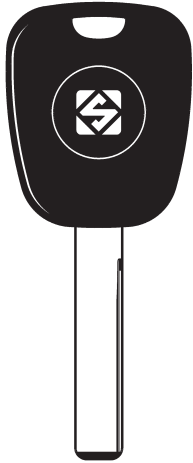

HU92RP

OPTIONAL

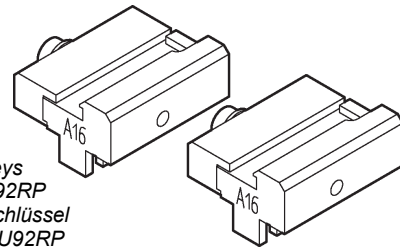

**D727645ZB**

Adaptors A16 for HU92RP keys  
Adattatori A16 per chiavi HU92RP  
Adapters A16 für HU92RP Schlüssel  
Adaptateurs A16 pour clés HU92RP  
Adaptadores A16 para llaves HU92RP  
Adaptadores A16 para chaves HU92RP

STANDARD



**D741432ZB**

Tracer point TE04  
Tastatore TE04  
Taster TE04  
Palpeur TE04  
Palpador TE04  
Palpador TE04



**D749544ZB**

Cutter FE04  
Fresa FE04  
Fräser FE04  
Fraise FE04  
Fresa FE04  
Fresa FE04

PER:  
FOR:

HUF (D)



HU83T5



HU83T



HU107T

STANDARD



**D741432ZB**

Tracer point TE04  
Tastatore TE04  
Taster TE04  
Palpeur TE04  
Palpador TE04  
Palpador TE04



**D749544ZB**

Cutter FE04  
Fresa FE04  
Fräser FE04  
Fraise FE04  
Fresa FE04  
Fresa FE04



# SWIFT - SWIFT PLUS



PER:  
FOR:

## MERCEDES (D)

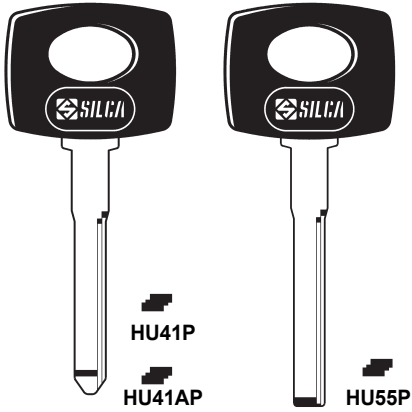

STANDARD



for machines:  
**D849470ZB**  
**D749780ZB**  
**D849781ZB**

OPTIONAL

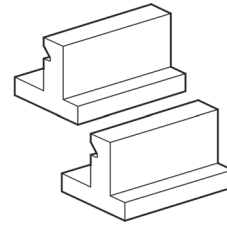

### D749777ZB

*Adapters for MERCEDES keys*  
*Adattatori per chiavi MERCEDES*  
*Adapters für MERCEDES Schlüssel*  
*Adaptateurs pour clés MERCEDES*  
*Adaptadores para llaves MERCEDES*  
*Adaptadores para chaves MERCEDES*

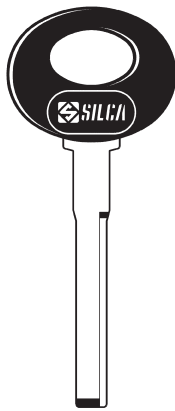

**HU61AP**

STANDARD



### D741432ZB

*Tracer point TE04*  
*Tastatore TE04*  
*Taster TE04*  
*Palpeur TE04*  
*Palpador TE04*  
*Palpador TE04*



### D749544ZB

*Cutter FE04*  
*Fresa FE04*  
*Fräser FE04*  
*Fraise FE04*  
*Fresa FE04*  
*Fresa FE04*



**HU64P**

**HU64T**  
**HUF (D)**

**HU65AP**







# SWIFT - SWIFT PLUS

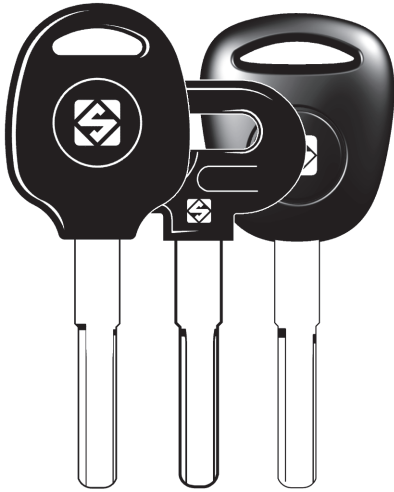

PER:  
FOR:

## SAAB (S)



 **YM30BP**     **YM30P**     **YM30T5**  
 VALEO-YMOS (D)    YMOS (D)

### STANDARD



for machines:  
**D749518ZB**  
**D749522ZB**

### OPTIONAL



#### D749778ZB

Adaptors  
Adattatori  
Adapters  
Adaptateurs  
Adaptadores  
Adaptadores

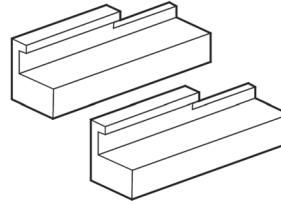

### STANDARD



#### D741432ZB

Tracer point TE04  
Tastatore TE04  
Taster TE04  
Palpeur TE04  
Palpador TE04  
Palpador TE04



#### D749544ZB

Cutter FE04  
Fresa FE04  
Fräser FE04  
Fraise FE04  
Fresa FE04  
Fresa FE04

PER:  
FOR:

## TRW SIPEA (I)

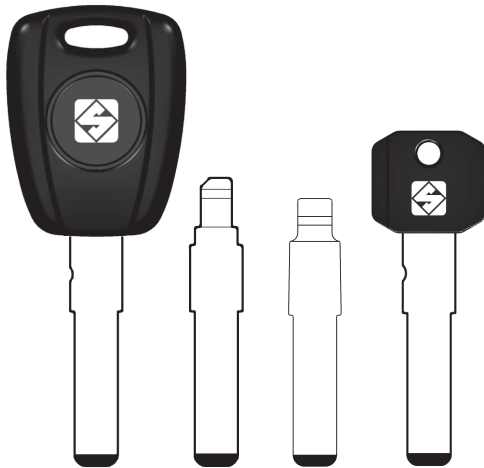

 **SIP22LP**     **SIP29T**     **SIP18T**     **SIP22KP**  
 **SIP22T5**

### OPTIONAL



#### D741434ZB

Tracer point TE05  
Tastatore TE05  
Taster TE05  
Palpeur TE05  
Palpador TE05  
Palpador TE05



#### D741435ZB

Cutter FE05  
Fresa FE05  
Fräser FE05  
Fraise FE05  
Fresa FE05  
Fresa FE05



# SWIFT - SWIFT PLUS



PER:  
FOR: **TOYOTA (J)**



  
**TOY40BT4**  
TOY40  
TOY40P  
TOY40AP

  
**TOY48P**  
  
**TOY48BT4**  
ARISTO

STANDARD



**D741432ZB**  
Tracer point TE04  
Tastatore TE04  
Taster TE04  
Palpeur TE04  
Palpador TE04  
Palpador TE04



**D749544ZB**  
Cutter FE04  
Fresa FE04  
Fräser FE04  
Fraise FE04  
Fresa FE04  
Fresa FE04

PER:  
FOR: **VALEO (F)**



  
**VA2T14**  **VA6 ...**

STANDARD



**D741432ZB**  
Tracer point TE04  
Tastatore TE04  
Taster TE04  
Palpeur TE04  
Palpador TE04  
Palpador TE04



**D749544ZB**  
Cutter FE04  
Fresa FE04  
Fräser FE04  
Fraise FE04  
Fresa FE04  
Fresa FE04



# SWIFT - SWIFT PLUS



PER:  
FOR:

## VOLVO (S)

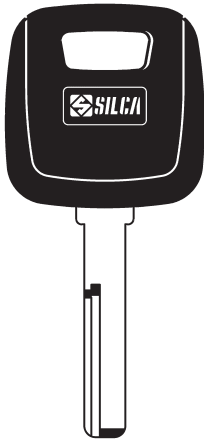

  
HU56RAT2

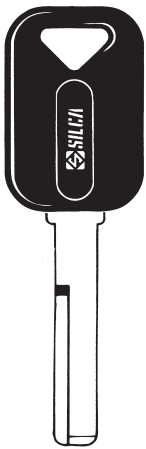

  
HU57RP

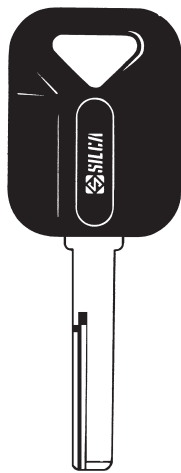

  
HU56RP

### STANDARD



#### D741432ZB

Tracer point TE04  
Tastatore TE04  
Taster TE04  
Palpeur TE04  
Palpador TE04  
Palpador TE04

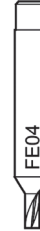

#### D749544ZB

Cutter FE04  
Fresa FE04  
Fräser FE04  
Fraise FE04  
Fresa FE04  
Fresa FE04

PER:  
FOR:

## ZADI (I)

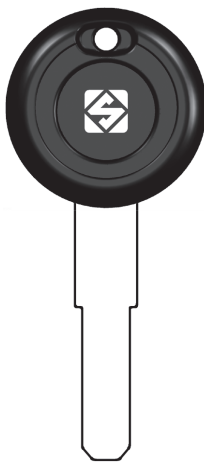

  
ZD30T5

### OPTIONAL



#### D741434ZB

Tracer point TE05  
Tastatore TE05  
Taster TE05  
Palpeur TE05  
Palpador TE05  
Palpador TE05

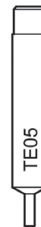

#### D741435ZB

Cutter FE05  
Fresa FE05  
Fräser FE05  
Fraise FE05  
Fresa FE05  
Fresa FE05



# SWIFT - SWIFT PLUS



PER:  
FOR:

**AUDI (D)**  
**FORD (D)**  
**PORSCHE (D)**  
**SEAT (E)**  
**SKODA (CZ)**  
**VOLKSWAGEN (D)**

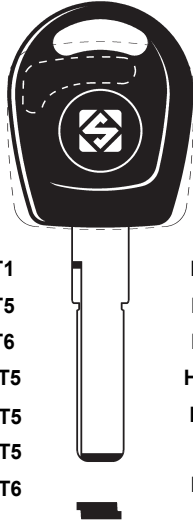

HU66T1	HU66AT6
HU66T5	HU66T10
HU66T6	HU66T15
HU66AT5	HU66BT15
HU66CT5	HU66BT1
HU66DT5	HU66PL
HU66CT6	HU66T5L
	HU75T
	HU103T

HUF (D)  
WITTE (D)

STANDARD



for machines:  
**D749518ZB**  
**D749522ZB**

OPTIONAL



**D749778ZB**

*Adaptors*  
*Adattatori*  
*Adapters*  
*Adapteurs*  
*Adaptadores*  
*Adaptadores*

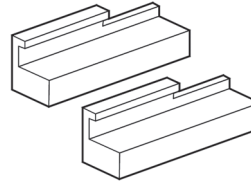

STANDARD



**D741432ZB**

*Tracer point TE04*  
*Tastatore TE04*  
*Taster TE04*  
*Palpeur TE04*  
*Palpador TE04*  
*Palpador TE04*



**D749544ZB**

*Cutter FE04*  
*Fresa FE04*  
*Fräser FE04*  
*Fraise FE04*  
*Fresa FE04*  
*Fresa FE04*

PER:  
FOR:

<b>CENTURY (USA)</b>	CEN5T (10)
<b>CHICAGO (USA)</b>	CH16T (9.2) CH17T (10)
<b>L&amp;F (GB)</b>	
<b>ERA (GB)</b>	
<b>AGA (E)</b>	
<b>MERONI (I)</b>	MER22T (9.50) MER25T (9.50)
<b>P.CORTELLEZZI (I)</b>	PC12T (9.60) PC12TP (9.60) PC15T (9.60) PC15TP (9.60)
<b>SILCA (I)</b>	SLC1TP (9.60) SLC2TP (9.60)
<b>SIDLEEN (USA)</b>	SD3T (9.50)

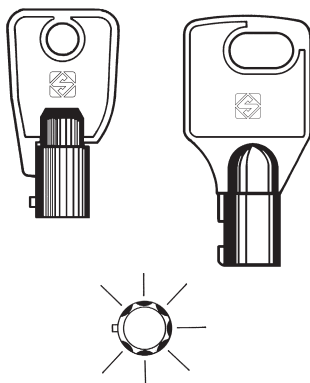

STANDARD



for machines:  
**D749518ZB**  
**D749522ZB**  
**D749524ZB**  
**D749780ZB**

OPTIONAL



for machines:  
**D748250ZB**  
**D849470ZB**  
**D849781ZB**  
**D849782ZB**

**D741438ZB**

*Tracer point TE07*  
*Tastatore TE07*  
*Taster TE07*  
*Palpeur TE07*  
*Palpador TE07*  
*Palpador TE07*



**D749545ZB**

*Cutter FE07*  
*Fresa FE07*  
*Fräser FE07*  
*Fraise FE07*  
*Fresa FE07*  
*Fresa FE07*

